

November 2010



# MULTILAYER CHIP COMPONENTS

CHIP INDUCTOR / BEADS

EMI / ESD PRODUCTS

PRODUCTS for COMMUNICATION EQUIPMENT

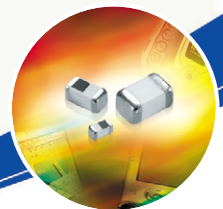

**SAMSUNG  
ELECTRO-MECHANICS**



[www.cxgeo.cn](http://www.cxgeo.cn)

# CONTENTS



## **Product Guide** ..... 4

### **Chip Beads**

CIB/CIM Series	6
CIA Series	22
CIC/CIS Series	26
CIV Series	36



### **Chip Inductors**

CIL Series	38
CIH Series	44
Power Inductor	48



### **EMI Products**

EMI Filter	54
3-Terminal Capacitor	57

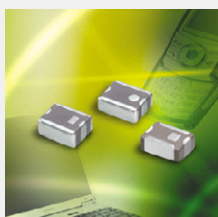

### **Products For Communication Equipment**

Diplexer	59
Band Pass/Low Pass Filter	62



### **Appendix**

Soldering Condition	68
Packaging	69

**Bead**

Type	Series	Size Code mm (inch)	Impedance Range ( $Z$ ) at 100MHz	Effective Frequency Range				
				1MHz	10MHz	100MHz	1GHz	10GHz
General Signal  CIB:monolayer CIM:multilayer	CIB10P	1608(0603)	26~33					
	CIB21P	2012(0805)	11~47					
	CIB31P	3216(1206)	26~70					
	CIB32P~	3225(1210)	31~150					
	CIM03U	0603(0201)	120~240					
	CIM05U	1005(0402)	10~1000					
	CIM10U	1608(0603)	120~2000					
	CIM21U	2012(0805)	80~2000					
	CIM31U	3216(1206)	10~600					
High speed signal	CIM03J	0603(0201)	120~240					
	CIM05J	1005(0402)	30~1800					
	CIM10J	1608(0603)	40~1500					
	CIM21J	2012(0805)	26~2000					
	CIM31J	3216(1206)	150~1500					
	CIM03N	0603(0201)	30~80					
	CIM10N	1608(0603)	70~240					
	CIM21N	2012(0805)	70~240					
	CIM10K	1608(0603)	1500~2500					
	CIM21K	2012(0805)	1500~2500					
	CIM05F	1005(0402)	5~220					
CIM10F	1608(0603)	47~470						
High Current	CIC05P	1005(0402)	30~120					
	CIC10P	1608(0603)	8~300					
	CIC21P	2012(0805)	11~220					
	CIC31P	3216(1206)	30~600					
	CIC41P	4516(1806)	80~600					
	CIC43P	4532(1812)	30~600					
	CIC05J	1005(0402)	60					
	CIC10J	1608(0603)	6~600					
	CIC21J	2012(0805)	60~600					
	CIC31J	3216(1206)	30~600					
	CIC41J	4516(1806)	40~600					
CIC43J	4532(1812)	30~600						
Array	CIA31U	3216(1206)	30~1000					
	CIA31J	3216(1206)	30~1000					
	CIA31N	3216(1206)	80~240					
Ultra high current	CIS10J~CIS41J	1608(0603)~4532(1812)	30~120					
	CIS21P~CIS43P	2012(0805)~4532(1812)	30~240					
GHz Band Noise Suppression	CIV05U	1005(0402)	600~1000					
	CIV05J	1005(0402)	1000~1800					

## Inductor

Type	Series	Size Code mm (inch)	Inductance(H) Range							
			1n	10n	100n	1u	10u	100u	1m	
General Frequency range	CIL05	1005(0402)					2.2uH			
	CIL10	1608(0603)							0.047~33uH	
	CIL21	2012(0805)							0.047~33uH	
	CIL31	3216(1206)							0.047~33uH	
High Frequency range	CIH03T	0603(0201)			1~56nH					
	CIH05T	1005(0402)			1~100nH					
	CIH10T	1608(0603)			1~270nH					
DC-DC converter (Power Inductor)	CIG10F(Low Profile)	1608(0603)							0.047~2.2uH	
	CIG10W(Normal)	1608(0603)							0.47~4.7uH	
	CIG21F(Low Profile)	2012(0805)							0.47~2.2uH	
	CIG21W(Normal)	2012(0805)							1.0~4.7uH	
	CIG21L(Low RDC)	2012(0805)							0.47~4.7uH	
	CIG21C	2012(0805)							2.2~4.7uH	
	CIG22L(Low RDC)	2520(1008)							0.47~4.7uH	
	CIG22H(High Current)	2520(1008)							1.0~4.7uH	
CIG22B	2520(1008)							1.0~4.7uH		

## Filters

Type	Series	Size Code mm (inch)
EMI filter	EMIL10C	1608(0603)
	EMIL21C	2012(0805)
3-Terminal capacitor	EMIC10B	1608(0603)
	EMIC21B	2012(0805)
	EMIC21F	2012(0805)
	EMIC31B	3216(1206)
Diplexer	DX21	2012(0805)
LC Filter Diplexer	LCB10	1608(0603)
	LCB21	2012(0805)
	LCB22	2520(1008)

# Chip Bead; CIB/CIM Series For EMI Suppression

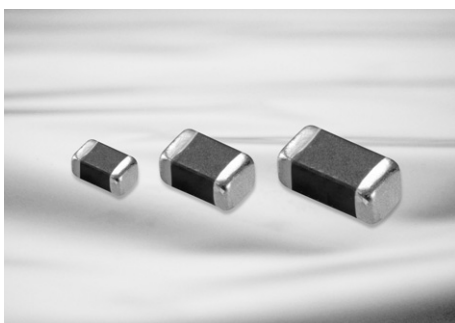

## Feature

- Smallest beads suitable for surface mounting
- Perfect shape for automatic mounting, with no directionality.
- Excellent solderability and high heat resistance for either flow or reflow soldering.
- Monolithic inorganic material construction for high reliability.
- Closed magnetic circuit configuration avoids crosstalk and is suitable for high density PCBs.

## Application

- High frequency EMI prevention application to computers, printers, VCRs, TVs and mobile phones.

The CIB/CIM Series are used for EMI suppression filter. These beads suppress electro-magnetic wave noise by increased impedance, especially by increased resistance at noise frequency.

### CIB Series

The CIB Series is composed of mono-layer internal conductor that allows low impedance and low DC resistance.

### CIM Series

The CIM Series display high impedance because it is composed of a multilayered internal conductor and has excellent attenuation characteristics for wide band frequencies.

Operating Temp	-55~+125°C
Storage Temp	-10~+40°C

## Dimensions

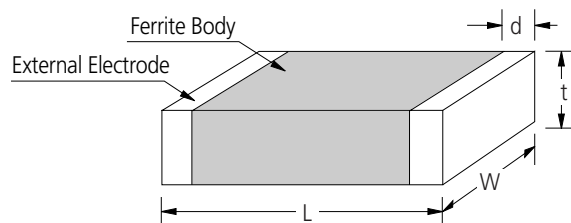

Unit: mm

SIZE CODE	L	W	t	d
03	0.6±0.03	0.3±0.03	0.3±0.03	0.15±0.05
05	1.0±0.05	0.5±0.05	0.5±0.05	0.25±0.1
10	1.6±0.15	0.8±0.15	0.8±0.15	0.3±0.2
21	2.0±0.2	1.25±0.2	0.9±0.2	0.5+0.2,-0.3
31	3.2±0.2	1.6±0.2	1.1±0.2	0.5+0.2,-0.3
32	3.2±0.2	2.5±0.2	1.3±0.2	0.5±0.3
41	4.5±0.2	1.6±0.2	1.6±0.2/1.2±0.2	0.5±0.3
43	4.5±0.2	3.2±0.2	1.5±0.2	0.5±0.3

## Part Numbering

**CI**   **M**   **03**   **J**   **121**   **N**   **C**  
 (1)   (2)   (3)   (4)   (5)   (6)   (7)

(1) Chip Beads

(2) B: Mono-layer type, M: Multi-layer type

(3) Dimension

(4) Material Code

P,U: Broad impedance, especially suppresses noise in the 10~200MHz range

J : Suppresses noise in the 100~300MHz range

K : Suppresses noise in the 200MHz above

N : Suppresses noise in the 200~500MHz range

(5) Nominal impedance (110: 11Ω ; 121: 120Ω)

(6) Thickness option (N: Standard, A: Thinner than standard, B: Thicker than standard)

(7) Packaging (C: paper tape, E: embossed tape)

## CIM 0603(0201) Type

Part No.	Thickness (mm)	Impedance ( $\Omega$ ) $\pm 25\%$ @ 100 MHz	DC Resistance ( $\Omega$ ) Max.	Rated Current (mA) Max.
CIM 03N 300	0.3 $\pm$ 0.03	30	0.8	150
CIM 03N 800	0.3 $\pm$ 0.03	80	1.2	100
CIM 03U 800	0.3 $\pm$ 0.03	80	0.5	200
CIM 03U 121	0.3 $\pm$ 0.03	120	0.8	200
CIM 03U 241	0.3 $\pm$ 0.03	240	1.0	100
CIM 03J 121	0.3 $\pm$ 0.03	120	0.8	200
CIM 03J 241	0.3 $\pm$ 0.03	240	1.0	100

## Electrical Characteristics

**CIM03N300**

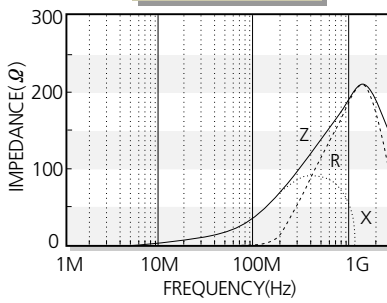

**CIM03N800**

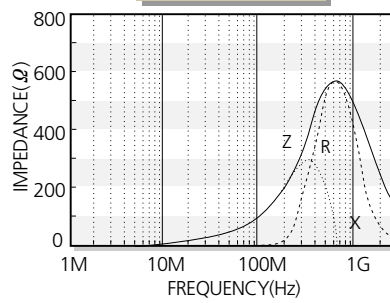

**CIM03U800**

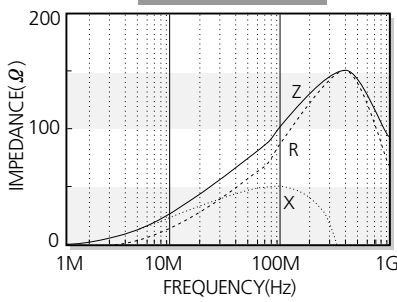

**CIM03U121**

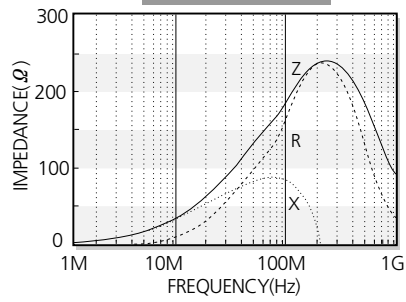

**CIM03U241**

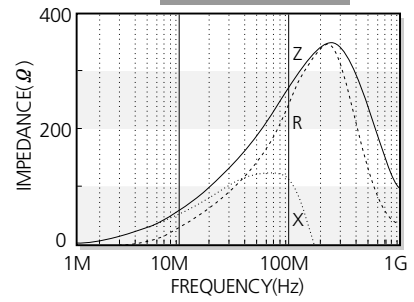

**CIM03J121**

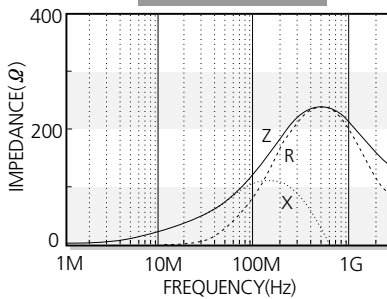

**CIM03J241**

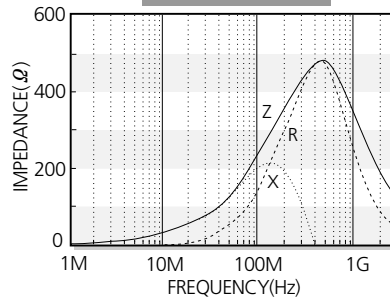



### CIM 1005(0402) Type

Part No.	Thickness (mm)	Impedance ( $\Omega$ ) $\pm$ 25% @ 100 MHz	DC Resistance ( $\Omega$ ) Max.	Rated Current (mA) Max.
CIM 05U 100	0.5 $\pm$ 0.05	10	0.05	1200
CIM 05U 300	0.5 $\pm$ 0.05	30	0.10	700
CIM 05U 600	0.5 $\pm$ 0.05	60	0.15	600
CIM 05U 800	0.5 $\pm$ 0.05	80	0.20	600
CIM 05U 121	0.5 $\pm$ 0.05	120	0.25	500
CIM 05U 221	0.5 $\pm$ 0.05	220	0.35	400
CIM 05U 241	0.5 $\pm$ 0.05	240	0.35	400
CIM 05U 301	0.5 $\pm$ 0.05	300	0.45	400
CIM 05U 471	0.5 $\pm$ 0.05	470	0.55	300
CIM 05U 601	0.5 $\pm$ 0.05	600	0.60	300
CIM 05U 102	0.5 $\pm$ 0.05	1000	1.00	200
CIM 05 J 300	0.5 $\pm$ 0.05	30	0.20	700
CIM 05 J 600	0.5 $\pm$ 0.05	60	0.20	600
CIM 05 J 800	0.5 $\pm$ 0.05	80	0.25	600
CIM 05 J 121	0.5 $\pm$ 0.05	120	0.30	500
CIM 05 J 221	0.5 $\pm$ 0.05	220	0.35	400
CIM 05 J 241	0.5 $\pm$ 0.05	240	0.35	400
CIM 05 J 301	0.5 $\pm$ 0.05	300	0.45	400
CIM 05 J 471	0.5 $\pm$ 0.05	470	0.55	300
CIM 05 J 601	0.5 $\pm$ 0.05	600	0.60	300
CIM 05 J 102	0.5 $\pm$ 0.05	1000	0.80	250
CIM 05 J 152	0.5 $\pm$ 0.05	1500	1.00	250
CIM 05 J 182	0.5 $\pm$ 0.05	1800	1.40	100
CIM 05 N 750	0.5 $\pm$ 0.05	75	0.35	300
CIM 05 N 121	0.5 $\pm$ 0.05	120	0.55	300
CIM 05 N 221	0.5 $\pm$ 0.05	220	0.80	200
CIM 05 F 050	0.5 $\pm$ 0.05	5	0.08	500
CIM 05 F 100	0.5 $\pm$ 0.05	10	0.10	300
CIM 05 F 220	0.5 $\pm$ 0.05	22	0.20	300
CIM 05 F 470	0.5 $\pm$ 0.05	47	0.35	300
CIM 05 F 750	0.5 $\pm$ 0.05	75	0.40	300
CIM 05 F 121	0.5 $\pm$ 0.05	120	0.55	300
CIM 05 F 221	0.5 $\pm$ 0.05	220	0.80	200

Electrical Characteristics

**CIM05U100**

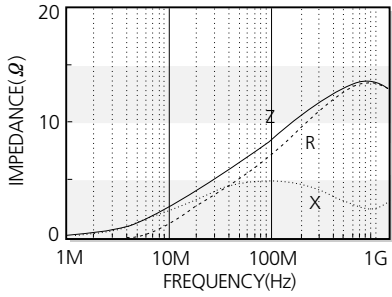

**CIM05U300**

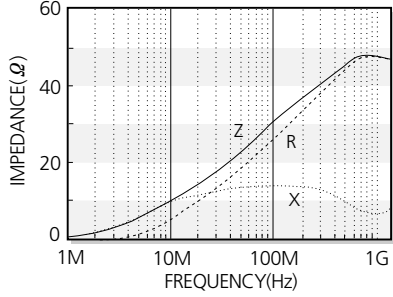

**CIM05U600**

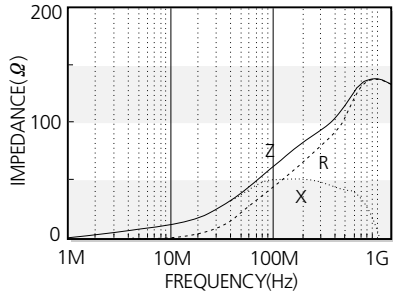

**CIM05U800**

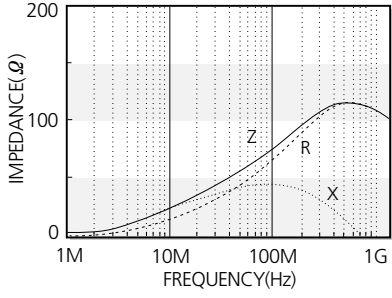

**CIM05U121**

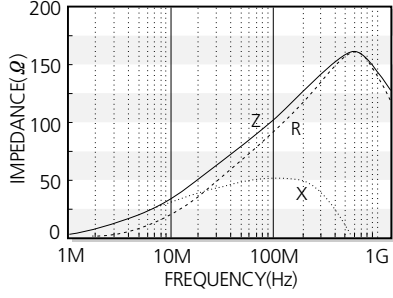

**CIM05U241**

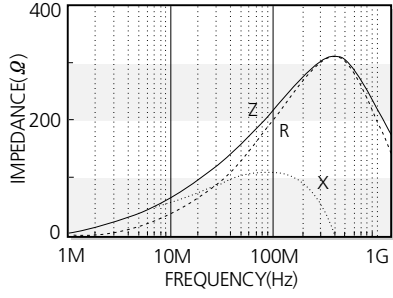

**CIM05U301**

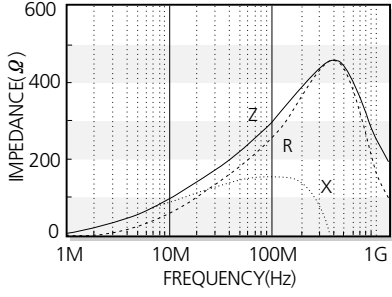

**CIM05U471**

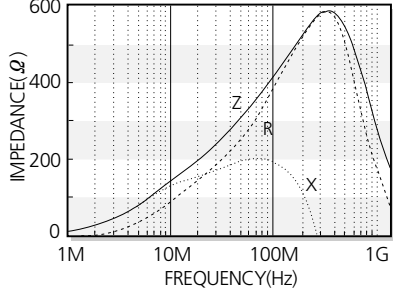

**CIM05U601**

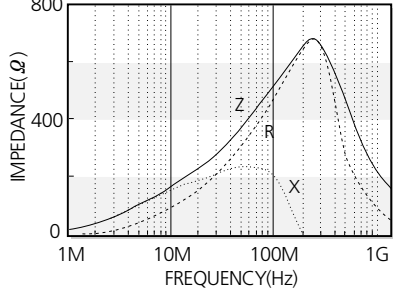

**CIM05U102**

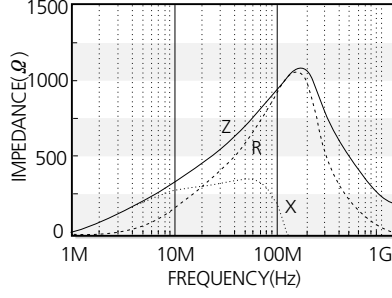

**CIM05N750**

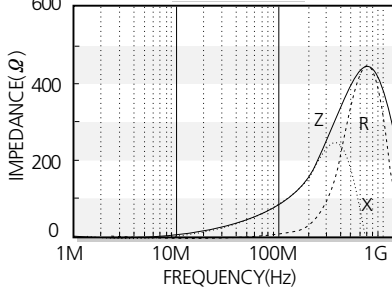

**CIM05N121**

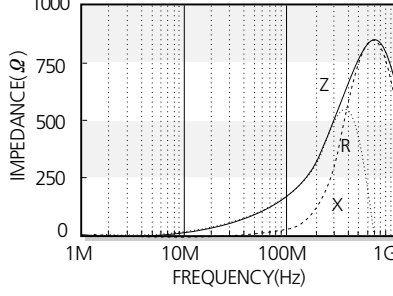

**CIM05N221**

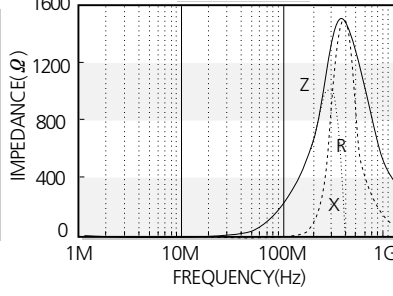



**Electrical Characteristics**

**CIM05J300**

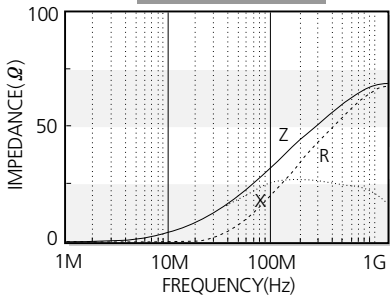

**CIM05J600**

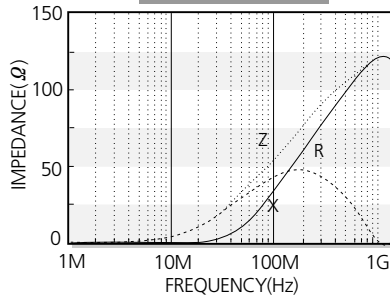

**CIM05J800**

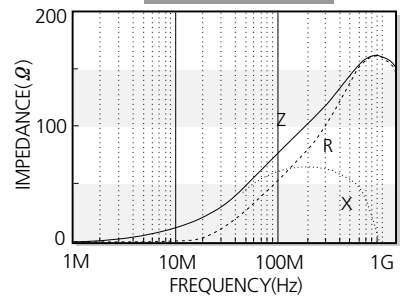

**CIM05J121**

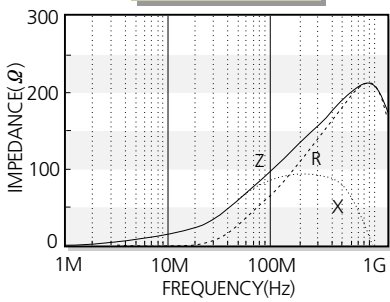

**CIM05J241**

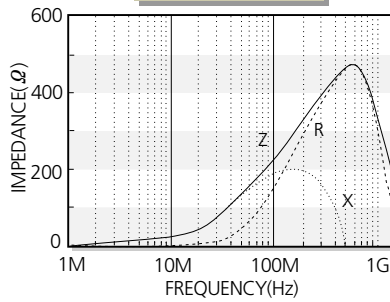

**CIM05J301**

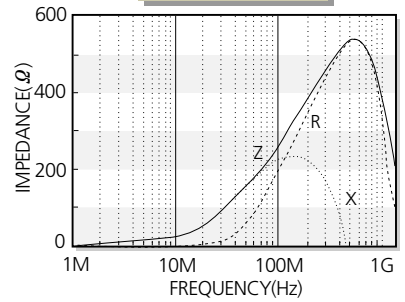

**CIM05J471**

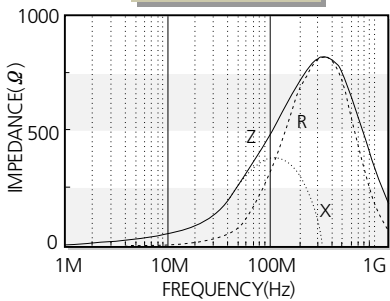

**CIM05J601**

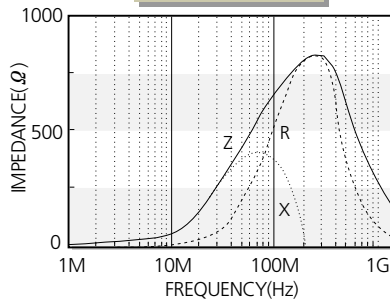

**CIM05J102**

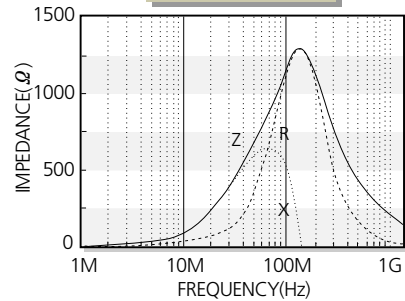

**CIM05J152**

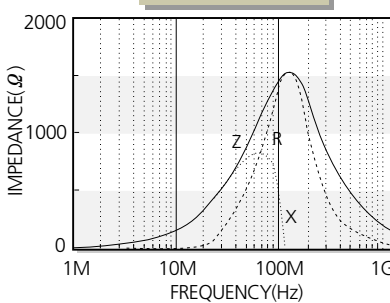

**CIM05J182**

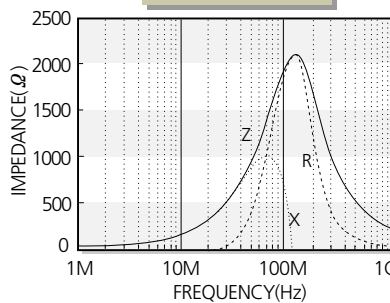

**CIM05F470**

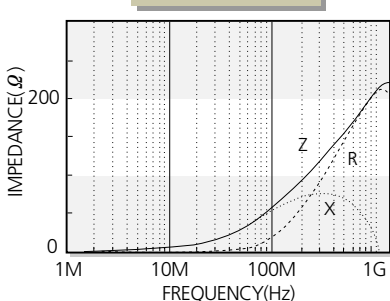

**CIM05F121**

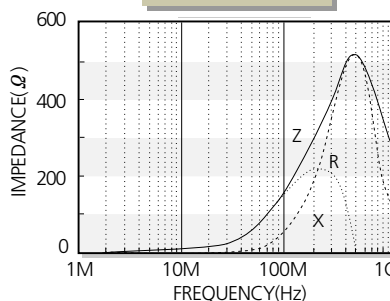

CIB/CIM 1608(0603) Type

Part No.	Thickness (mm)	Impedance ( $\Omega$ ) $\pm$ 25% @ 100 MHz	DC Resistance ( $\Omega$ ) Max.	Rated Current (mA) Max.
CIB 10P 100	0.8 $\pm$ 0.15	10	0.05	1000
CIB 10P 220	0.8 $\pm$ 0.15	22	0.05	1500
CIB 10P 260	0.8 $\pm$ 0.15	26	0.08	1000
CIB 10P 300	0.8 $\pm$ 0.15	30	0.08	1000
CIB 10J 300	0.8 $\pm$ 0.15	30	0.08	1000
CIB 10P 330	0.8 $\pm$ 0.15	33	0.08	1000
CIM 10U 800	0.8 $\pm$ 0.15	80	0.15	600
CIM 10U 121	0.8 $\pm$ 0.15	120	0.15	500
CIM 10U 221	0.8 $\pm$ 0.15	220	0.30	400
CIM 10U 241	0.8 $\pm$ 0.15	240	0.30	400
CIM 10U 471	0.8 $\pm$ 0.15	470	0.35	300
CIM 10U 601	0.8 $\pm$ 0.15	600	0.45	300
CIM 10U 102	0.8 $\pm$ 0.15	1000	0.60	250
CIM 10U 202	0.8 $\pm$ 0.15	2000(at 70MHz)	1.20	200
CIM 10J 400	0.8 $\pm$ 0.15	40	0.12	600
CIM 10J 470	0.8 $\pm$ 0.15	47	0.12	600
CIM 10J 600	0.8 $\pm$ 0.15	60	0.12	600
CIM 10J 750	0.8 $\pm$ 0.15	75	0.12	550
CIM 10J 800	0.8 $\pm$ 0.15	80	0.20	550
CIM 10J 121	0.8 $\pm$ 0.15	120	0.20	500
CIM 10J 151	0.8 $\pm$ 0.15	150	0.20	400
CIM 10J 221	0.8 $\pm$ 0.15	220	0.30	400
CIM 10J 241	0.8 $\pm$ 0.15	240	0.30	400
CIM 10J 301	0.8 $\pm$ 0.15	300	0.35	400
CIM 10J 331	0.8 $\pm$ 0.15	330	0.35	400
CIM 10J 471	0.8 $\pm$ 0.15	470	0.35	300
CIM 10J 601	0.8 $\pm$ 0.15	600	0.45	300
CIM 10J 751	0.8 $\pm$ 0.15	750	0.55	300
CIM 10J 102	0.8 $\pm$ 0.15	1000	0.70	250
CIM 10J 152	0.8 $\pm$ 0.15	1500	1.00	250
CIM 10J 252	0.8 $\pm$ 0.15	2500	1.50	200
CIM 10K 152	0.8 $\pm$ 0.15	1500	0.80	250
CIM 10K 202	0.8 $\pm$ 0.15	2000	1.00	200
CIM 10K 252	0.8 $\pm$ 0.15	2500	1.20	200
CIM 10N 700	0.8 $\pm$ 0.15	70	0.30	500
CIM 10N 121	0.8 $\pm$ 0.15	120	0.45	400
CIM 10N 241	0.8 $\pm$ 0.15	240	0.60	300
CIM 10 F 470	0.8 $\pm$ 0.15	47	0.25	550
CIM 10 F 600	0.8 $\pm$ 0.15	60	0.25	550
CIM 10 F 121	0.8 $\pm$ 0.15	120	0.30	500
CIM 10 F 331	0.8 $\pm$ 0.15	330	0.58	400
CIM 10 F471	0.8 $\pm$ 0.15	470	0.85	300

**Electrical Characteristics**

**CIB10P100**

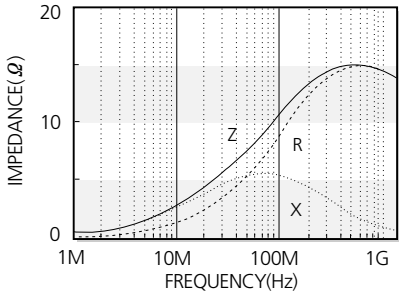

**CIB10P220**

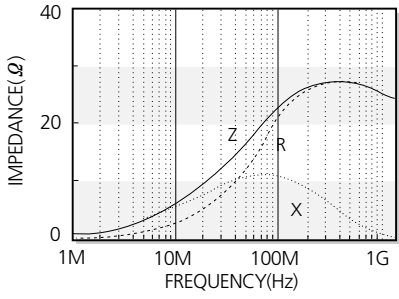

**CIB10P260**

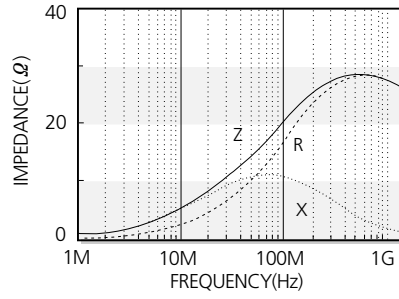

**CIB10P300**

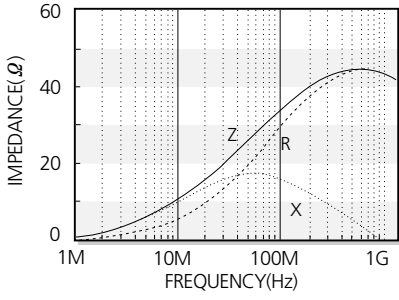

**CIB10J300**

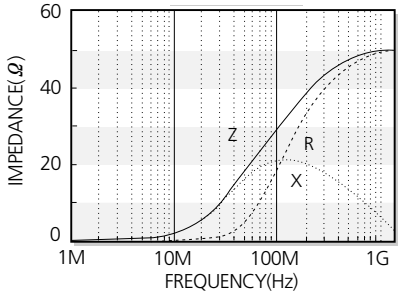

**CIB10P330**

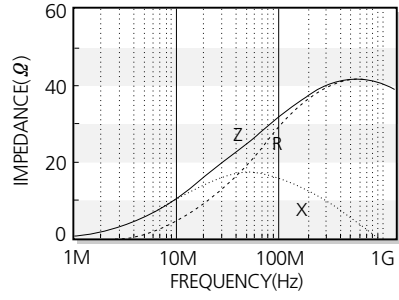

**CIM10U121**

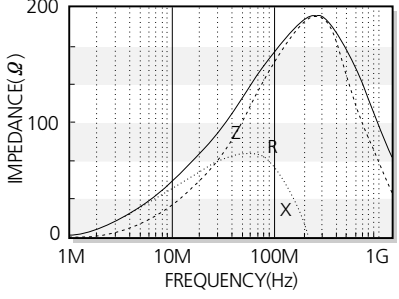

**CIM10U221**

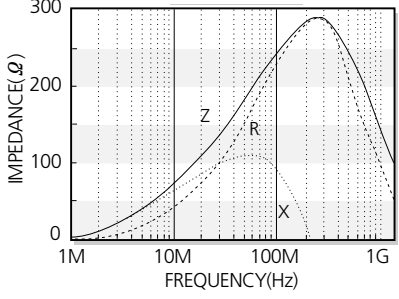

**CIM10U241**

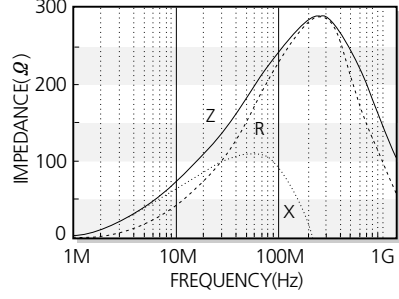

**CIM10U471**

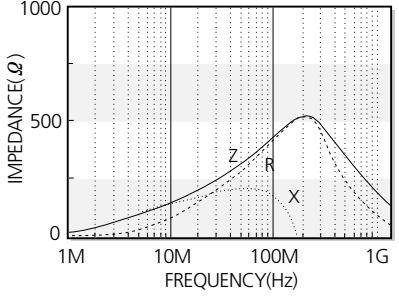

**CIM10U601**

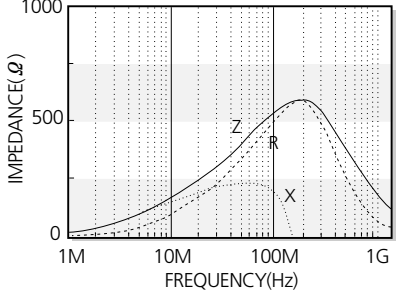

**CIM10U102**

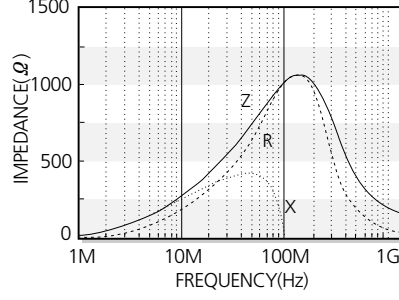

**CIM10U202**

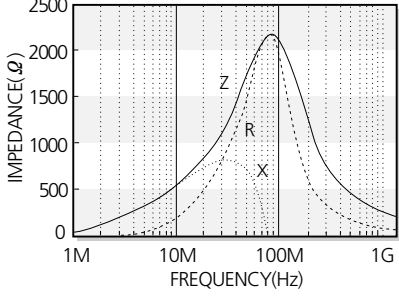

Electrical Characteristics

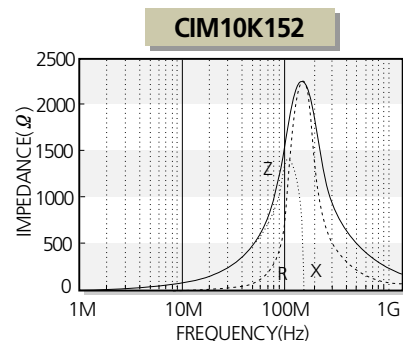
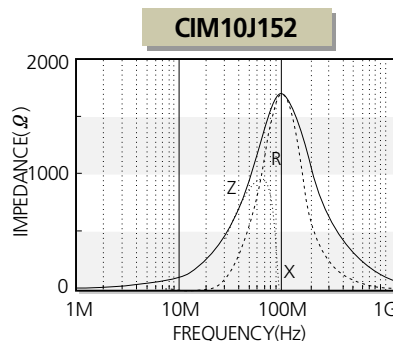
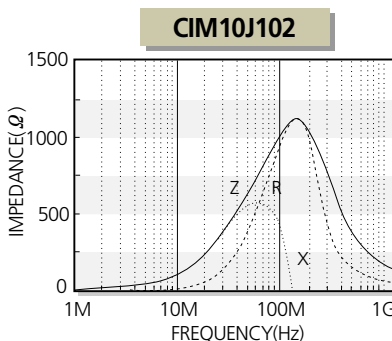
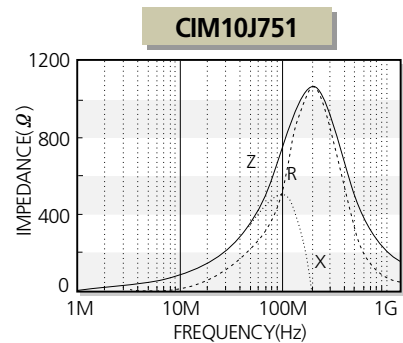
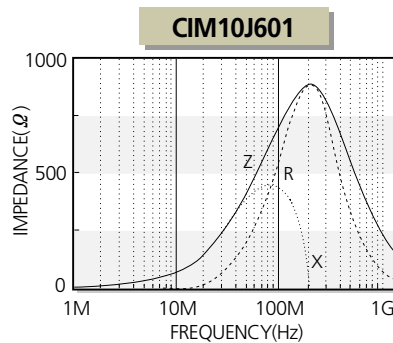
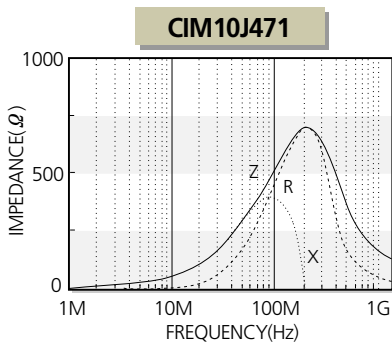
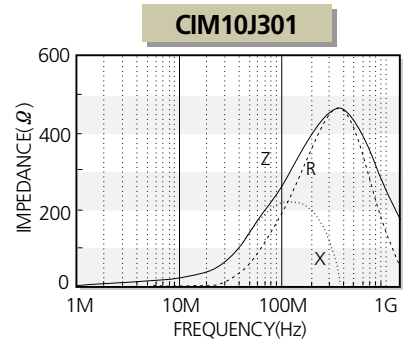
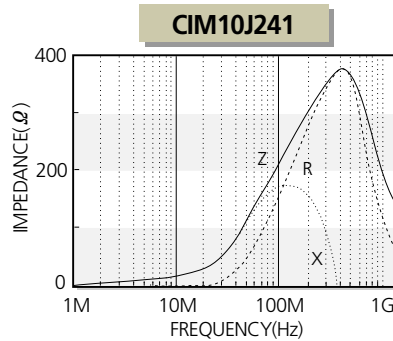
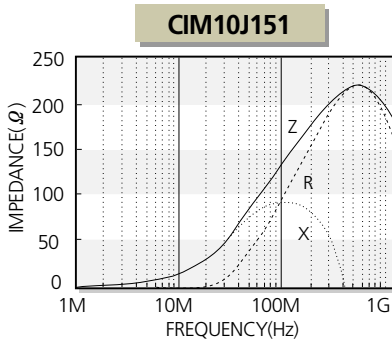
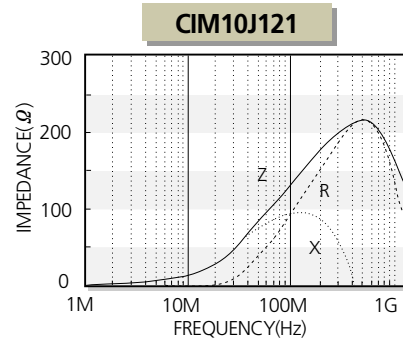
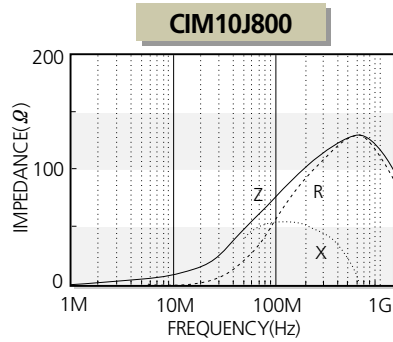
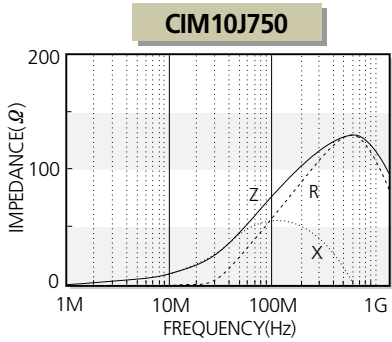
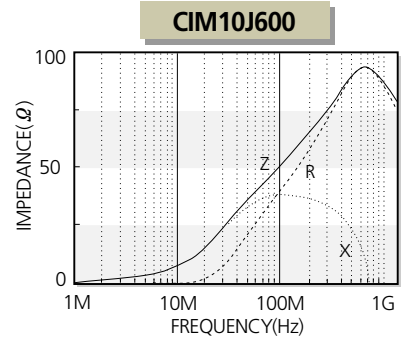
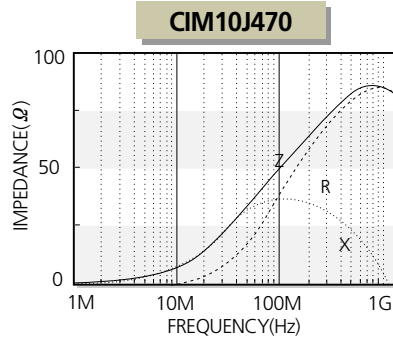
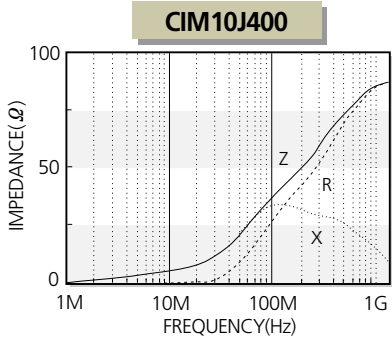



**CIM10K202**

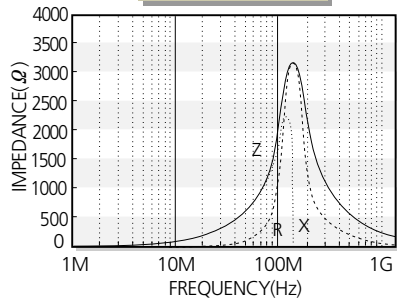

**CIM10K252**

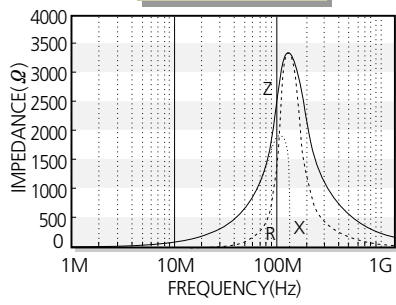

**CIM10N700**

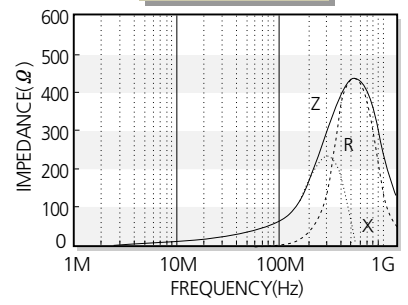

**CIM10N121**

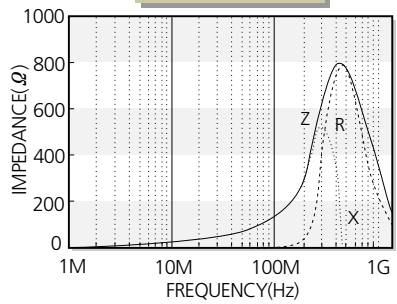

**CIM10N241**

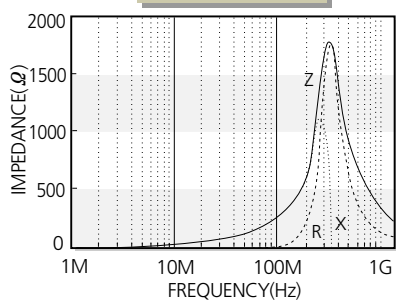

**CIM10F600**

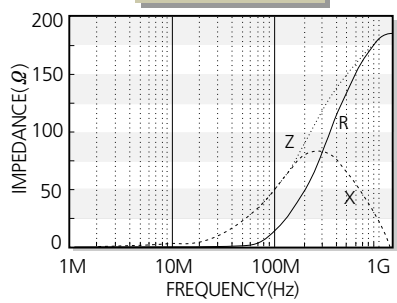

**CIM10F121**

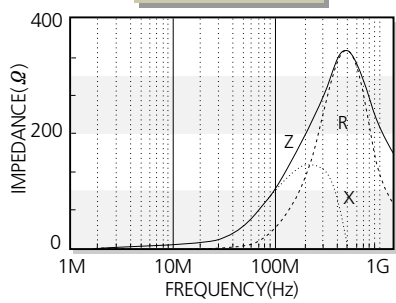

CIB/CIM 2012(0805) Type

Part No.	Thickness (mm)	Impedance ( $\Omega$ ) $\pm$ 25% @ 100 MHz	DC Resistance ( $\Omega$ ) Max.	Rated Current (mA) Max.
CIB 21P 110	0.9 $\pm$ 0.2	11	0.05	2000
CIB 21P 150	0.9 $\pm$ 0.2	15	0.05	2000
CIB 21P 260	0.9 $\pm$ 0.2	26	0.05	2000
CIB 21P 330	0.9 $\pm$ 0.2	33	0.05	1500
CIB 21P 470	0.9 $\pm$ 0.2	47	0.05	1500
CIM 21U 800	0.9 $\pm$ 0.2	80	0.10	900
CIM 21U 101	0.9 $\pm$ 0.2	100	0.10	500
CIM 21U 121	0.9 $\pm$ 0.2	120	0.10	500
CIM 21U 151	0.9 $\pm$ 0.2	150	0.15	400
CIM 21U 241	0.9 $\pm$ 0.2	240	0.15	400
CIM 21U 301	0.9 $\pm$ 0.2	300	0.15	400
CIM 21U 471	0.9 $\pm$ 0.2	470	0.25	400
CIM 21U 601	0.9 $\pm$ 0.2	600	0.30	400
CIM 21U 102	0.9 $\pm$ 0.2	1000(at 70MHz)	0.45	400
CIM 21U 202	0.9 $\pm$ 0.2	2000(at 70MHz)	0.70	300
CIB 21J 260	0.9 $\pm$ 0.2	26	0.05	2000
CIB 21J 400	0.9 $\pm$ 0.2	40	0.05	2000
CIM 21J 600	0.9 $\pm$ 0.2	60	0.08	900
CIM 21J 800	0.9 $\pm$ 0.2	80	0.08	900
CIM 21J 121	0.9 $\pm$ 0.2	120	0.15	600
CIM 21J 151	0.9 $\pm$ 0.2	150	0.15	500
CIM 21J 221	0.9 $\pm$ 0.2	220	0.02	400
CIM 21J 241	0.9 $\pm$ 0.2	240	0.20	400
CIM 21J 301	0.9 $\pm$ 0.2	300	0.25	400
CIM 21J 471	0.9 $\pm$ 0.2	470	0.25	400
CIM 21J 601	0.9 $\pm$ 0.2	600	0.25	400
CIM 21J 102	0.9 $\pm$ 0.2	1000	0.40	400
CIM 21J 152	0.9 $\pm$ 0.2	1500(at 70MHz)	0.55	300
CIM 21J 182	0.9 $\pm$ 0.2	1800(at 70MHz)	0.45	300
CIM 21J 202	0.9 $\pm$ 0.2	2000(at 70MHz)	0.50	300
CIM 21K 152	0.9 $\pm$ 0.2	1500	0.45	300
CIM 21K 252	0.9 $\pm$ 0.2	2500	0.80	250
CIM 21N 700	0.9 $\pm$ 0.2	70	0.20	600
CIM 21N 121	0.9 $\pm$ 0.2	120	0.25	500
CIM 21N 241	0.9 $\pm$ 0.2	240	0.3	400

**Electrical Characteristics**

**CIB21P110**

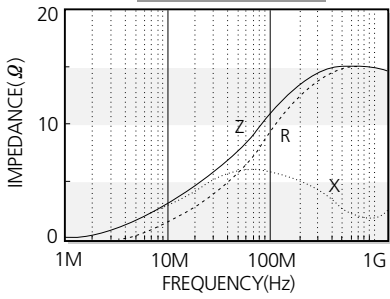

**CIB21P150**

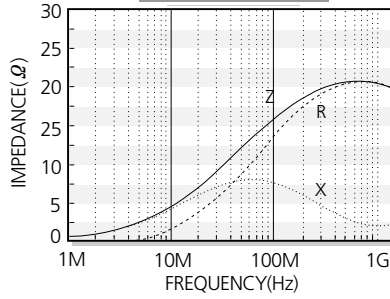

**CIB21P260**

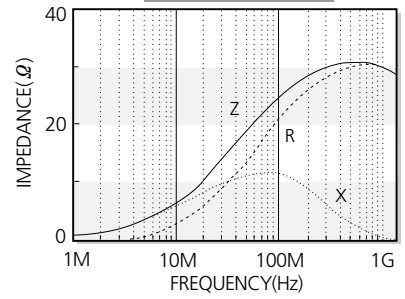

**CIB21P330**

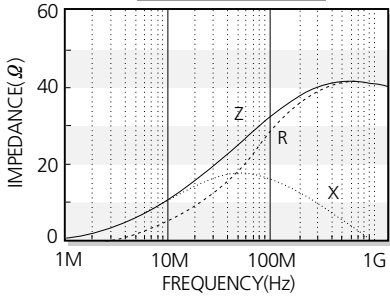

**CIB21P470**

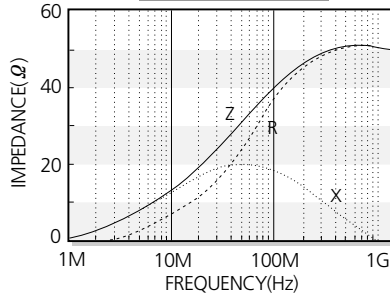

**CIM21U800**

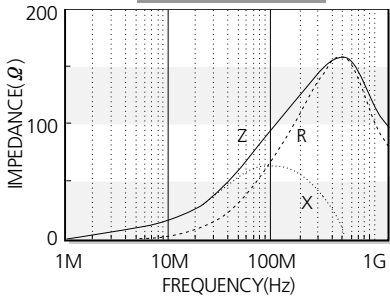

**CIM21U101**

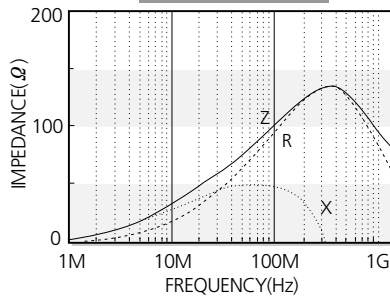

**CIM21U121**

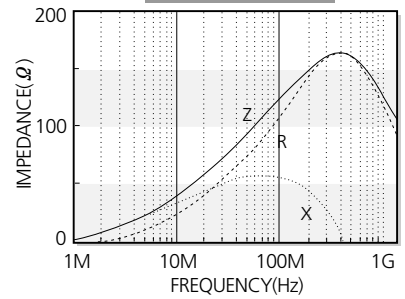

**CIM21U151**

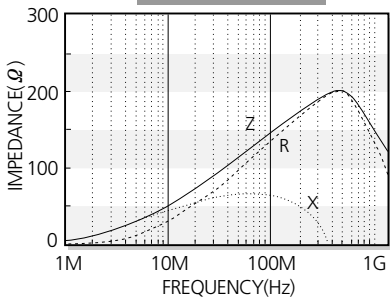

**CIM21U241**

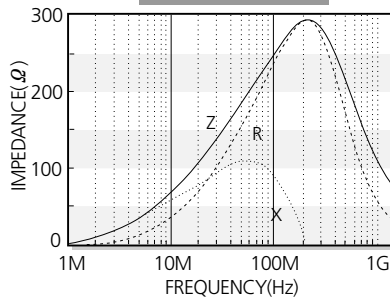

**CIM21U301**

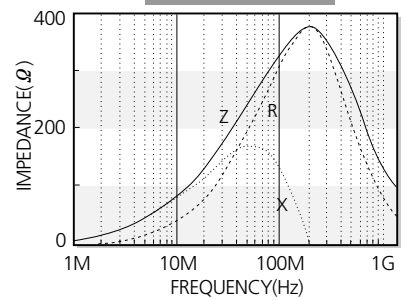

**CIM21U471**

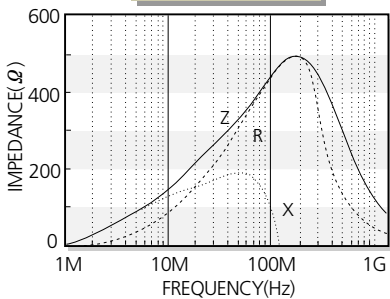

**CIM21U601**

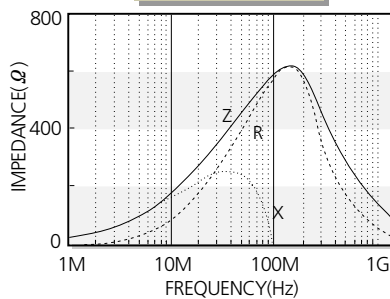

**CIM21U102**

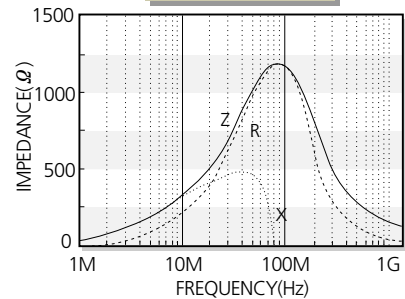

Electrical Characteristics

**CIM21U202**

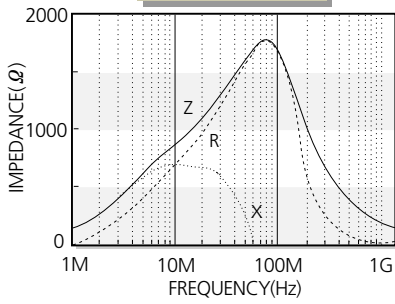

**CIB21J260**

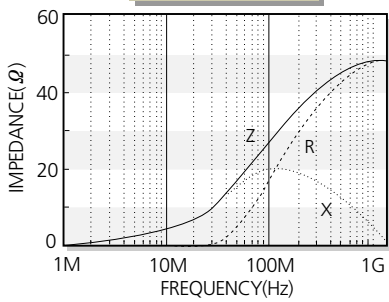

**CIB21J400**

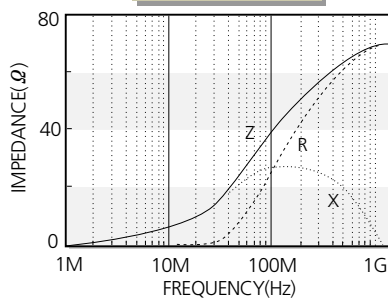

**CIM21J600**

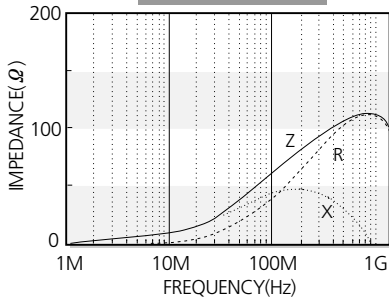

**CIM21J800**

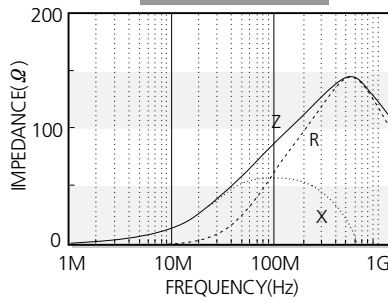

**CIM21J121**

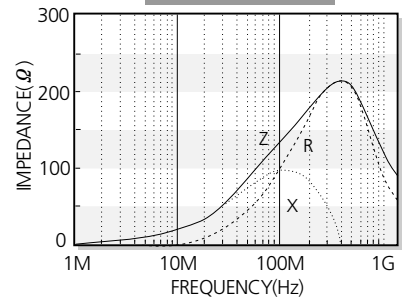

**CIM21J151**

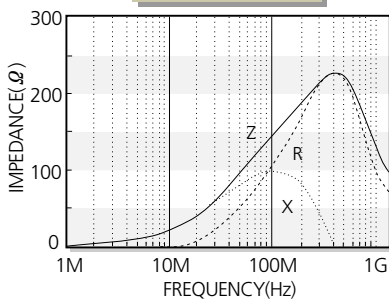

**CIM21J221**

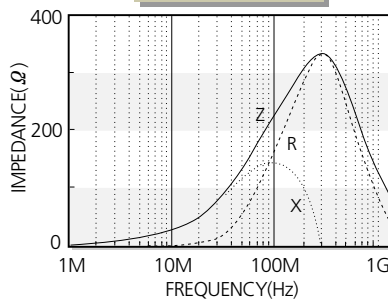

**CIM21J241**

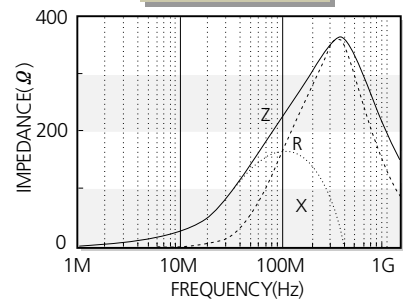

**CIM21J301**

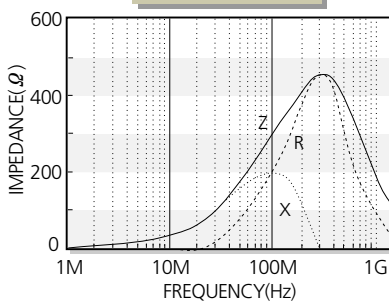

**CIM21J471**

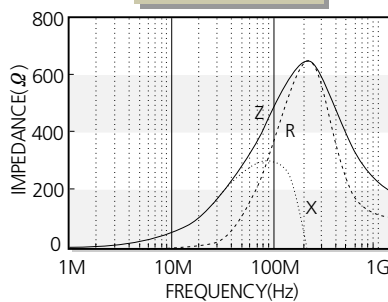

**CIM21J601**

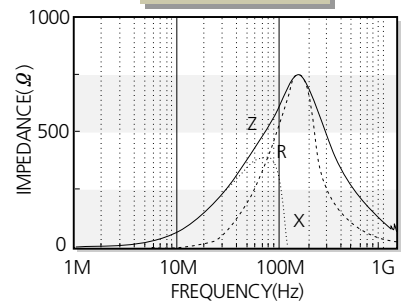



**Electrical Characteristics**

**CIM21J102**

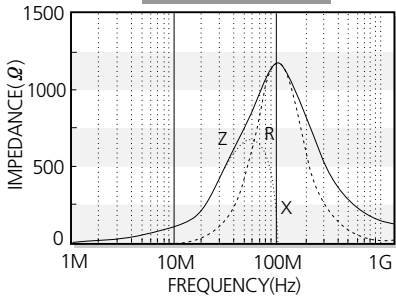

**CIM21J152**

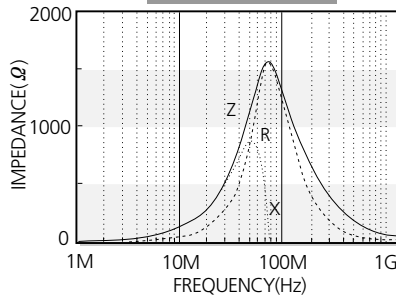

**CIM21J182**

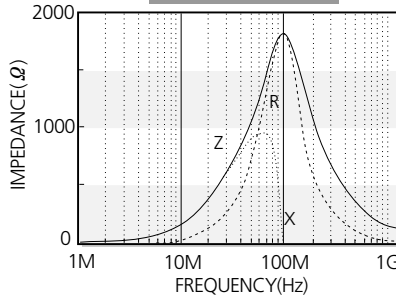

**CIM21J202**

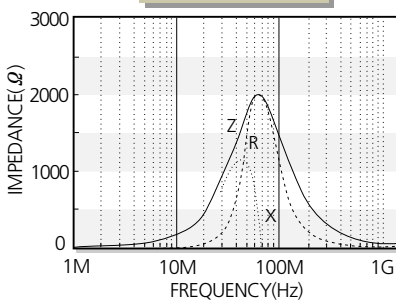

**CIM21K152**

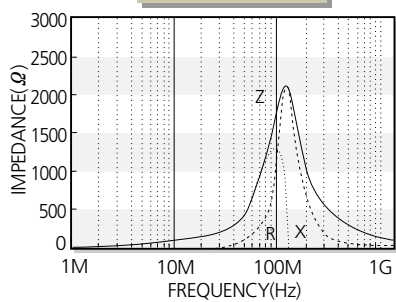

**CIM21K222**

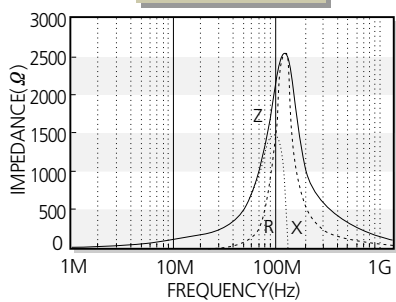

**CIM21K252**

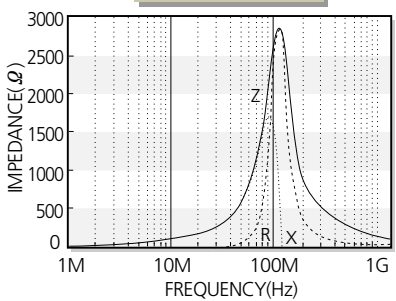

**CIM21N700**

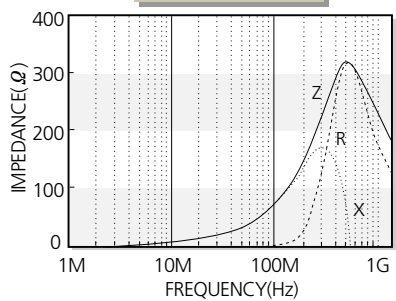

**CIM21N121**

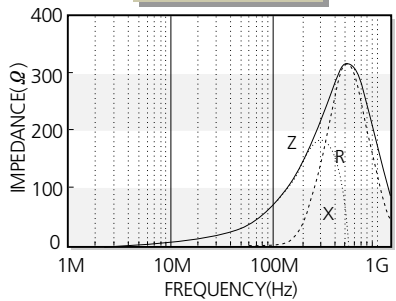

**CIM21N241**

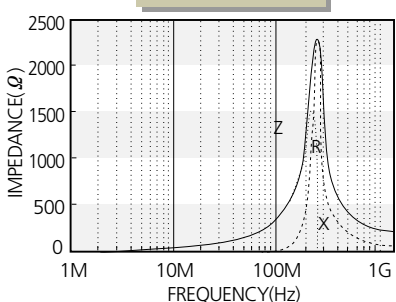

### CIB/CIM 3216(1206) Type

Part No.	Thickness (mm)	Impedance ( $\Omega$ ) $\pm$ 25% @ 100 MHz	DC Resistance ( $\Omega$ ) Max.	Rated Current (mA) Max.
CIB 31P 260	1.1 $\pm$ 0.2	26	0.05	2000
CIB 31P 310	1.1 $\pm$ 0.2	31	0.05	2000
CIB 31P 500	1.1 $\pm$ 0.2	50	0.05	2000
CIB 31P 700	1.1 $\pm$ 0.2	70	0.1	1500
CIM 31U 101	1.1 $\pm$ 0.2	100	0.15	500
CIM 31U 601	1.1 $\pm$ 0.2	600	0.3	400
CIM 31J 151	1.1 $\pm$ 0.2	150	0.2	500
CIM 31J 221	1.1 $\pm$ 0.2	220	0.2	400
CIM 31J 301	1.1 $\pm$ 0.2	300	0.25	400
CIM 31J 601	1.1 $\pm$ 0.2	600	0.3	400
CIM 31J 801	1.1 $\pm$ 0.2	800	0.4	400
CIM 31J 102	1.1 $\pm$ 0.2	1000	0.45	400
CIM 31J 152	1.1 $\pm$ 0.2	1500(at 70MHz)	0.55	300

### Other Types

Part No.	Thickness (mm)	Impedance ( $\Omega$ ) $\pm$ 25% @ 100 MHz	DC Resistance ( $\Omega$ ) Max.	Rated Current (mA) Max.
CIB 32P 310	1.3 $\pm$ 0.2	31	0.02	3000
CIB 32P 600	1.3 $\pm$ 0.2	60	0.02	1500
CIB 41P 800	1.6 $\pm$ 0.2	80	0.03	1000
CIB 41P 151	1.6 $\pm$ 0.2	150	0.05	1000
CIB 43P 131	1.5 $\pm$ 0.2	130	0.04	600
CIB 43P 151	1.5 $\pm$ 0.2	150	0.04	600

Customized products are available.

Test equipment : Agilent E4991A+16197A (0603)

Agilent 4291B+16192A (1005)

Agilent 4291B+16193A (1608 and others)

Electrical Characteristics

**CIB31P260**

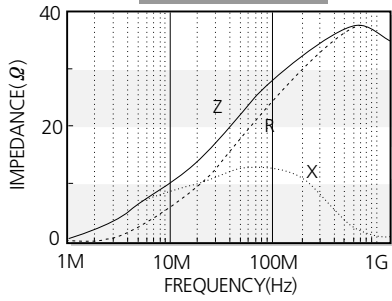

**CIB31P310**

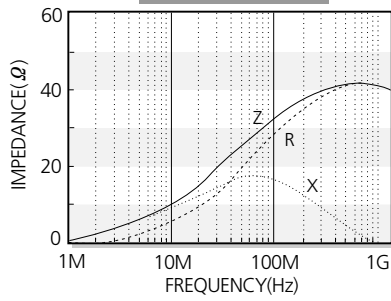

**CIB31P500**

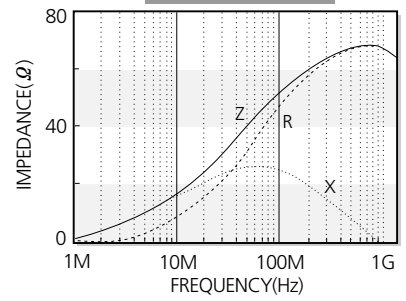

**CIB31P700**

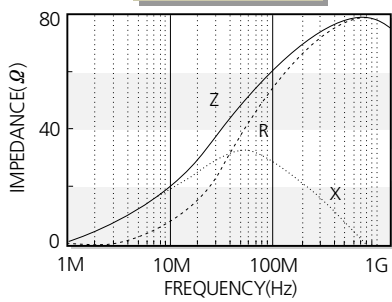

**CIM31U101**

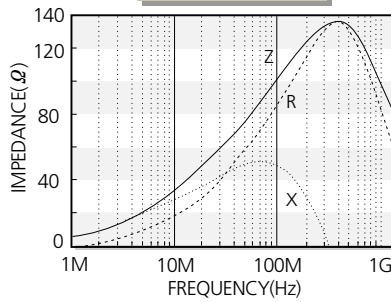

**CIM31U601**

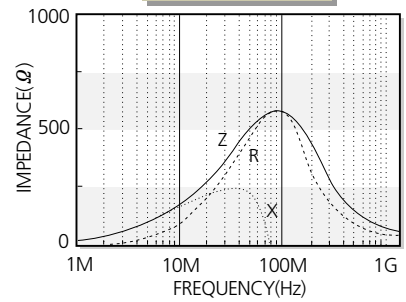

**CIM31J151**

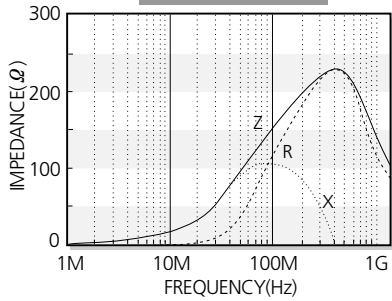

**CIM31J221**

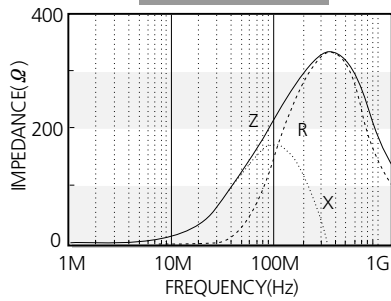

**CIM31J301**

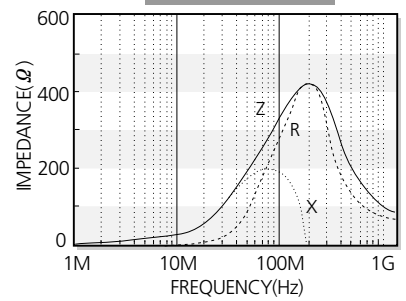

**CIM31J601**

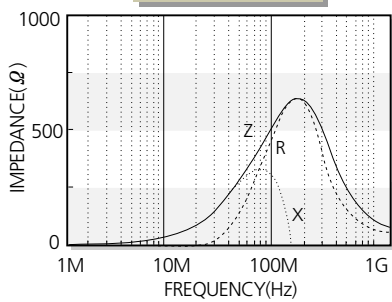

**CIM31J801**

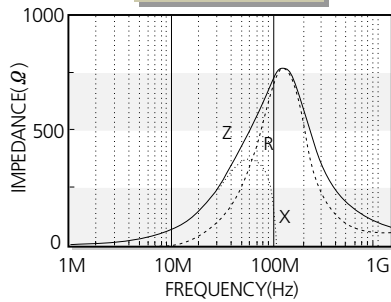

**CIM31J102**

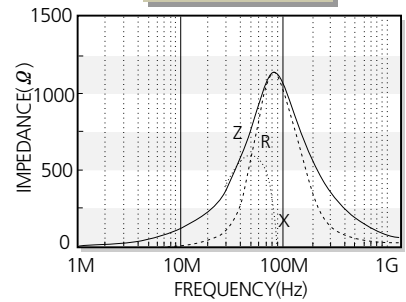

**CIM31J152**

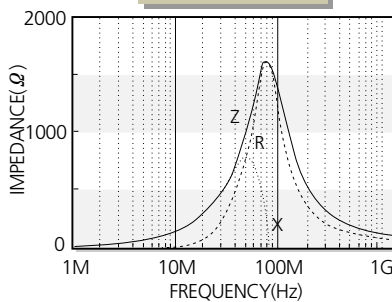

Electrical Characteristics

**CIB32P310**

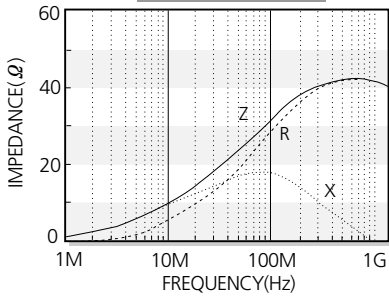

**CIB32P600**

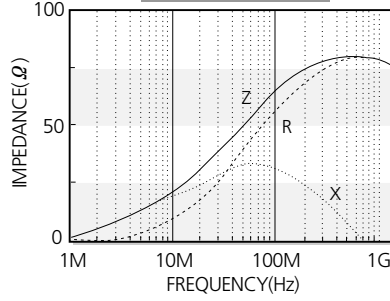

**CIB41P800**

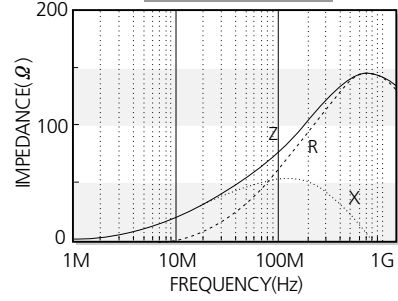

**CIB41P151**

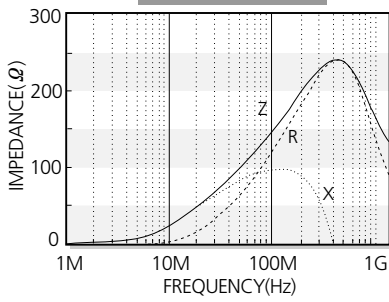

**CIB43P131**

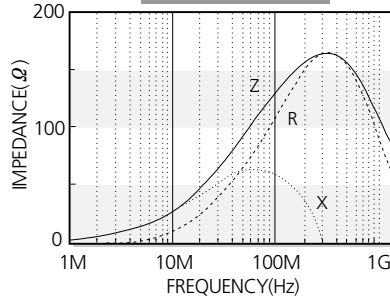

**CIB43P151**

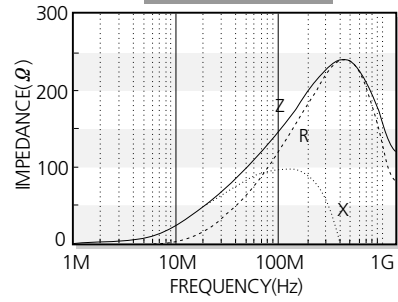

CIB/CIM  
Series

# Chip Bead Array; CIA Series For EMI Suppression

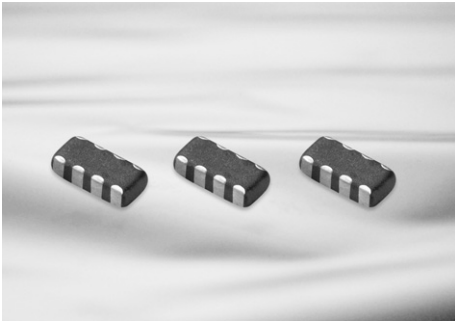

## Feature

- Four lines by one chip
- Perfect shape for automatic mounting, with no directionality.
- Excellent solderability and high heat resistance for either flow or reflow soldering.
- Closed magnetic circuit configuration with no cross-talk which is suitable for high density PCBs.

## Application

- EMI prevention in Notebook PC, LCD and car navigation
- Ideal for dealing with line noise from multiple signals such as in computer buses.

The CIA Series is an array of ferrite beads used for EMI suppression filters. This series is often used for high density Printed Circuit Boards to save the space and cost. It suppresses electro-magnetic wave noise by increased impedance, especially by increased resistance at noise frequency.

Operating Temp	-25~+85°C
Storage Temp	-40~+85°C

## Dimensions

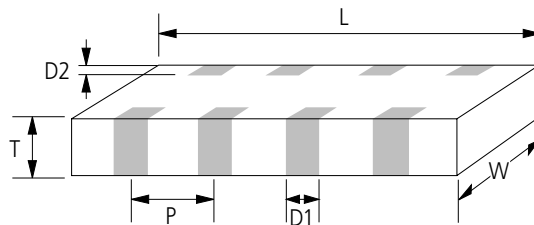

Unit: mm

SIZE CODE	L	W	T	D1	D2	P
31	3.2±0.2	1.6±0.2	0.8±0.2	0.4±0.2	0.3±0.15	0.8±0.1

## Part Numbering

**CI A 31 J 121 N E**  
(1) (2) (3) (4) (5) (6) (7)

- (1) Chip Beads
- (2) A: Bead array
- (3) Dimension
- (4) Material Code
  - U: Broad impedance, especially suppresses noise in the 10~200MHz range
  - J: Suppresses noise in the 100~300MHz range
  - N: Suppresses noise in the 200~500MHz range
- (5) Nominal Impedance (121: 120Ω, 300 : 30Ω)
- (6) Thickness option (N: Standard, A: Thinner than standard, B: Thicker than standard)
- (7) Packaging (C: paper tape, E: embossed tape)

## CIA 3216 (1206) Type

Part No.	Thickness (mm)	Impedance ( $\Omega$ ) $\pm 25\%$ @ 100 MHz	DC Resistance ( $\Omega$ ) Max.	Rated Current (mA) Max.
CIA 31U 300	0.8 $\pm$ 0.2	30	0.10	200
CIA 31U 600	0.8 $\pm$ 0.2	60	0.15	200
CIA 31U 800	0.8 $\pm$ 0.2	80	0.20	200
CIA 31U 121	0.8 $\pm$ 0.2	120	0.20	200
CIA 31U 221	0.8 $\pm$ 0.2	220	0.25	150
CIA 31U 241	0.8 $\pm$ 0.2	240	0.25	150
CIA 31U 301	0.8 $\pm$ 0.2	300	0.35	100
CIA 31U 471	0.8 $\pm$ 0.2	470	0.35	100
CIA 31U 601	0.8 $\pm$ 0.2	600	0.35	100
CIA 31U 102	0.8 $\pm$ 0.2	1000	0.45	50
CIA 31J 300	0.8 $\pm$ 0.2	30	0.15	300
CIA 31J 600	0.8 $\pm$ 0.2	60	0.15	300
CIA 31J 800	0.8 $\pm$ 0.2	80	0.20	300
CIA 31J 121	0.8 $\pm$ 0.2	120	0.20	300
CIA 31J 221	0.8 $\pm$ 0.2	220	0.35	300
CIA 31J 241	0.8 $\pm$ 0.2	240	0.35	300
CIA 31J 301	0.8 $\pm$ 0.2	300	0.40	300
CIA 31J 471	0.8 $\pm$ 0.2	470	0.40	300
CIA 31J 601	0.8 $\pm$ 0.2	600	0.45	200
CIA 31J 102	0.8 $\pm$ 0.2	1000	0.55	150
CIA 31N 800	0.8 $\pm$ 0.2	80	0.25	300
CIA 31N 121	0.8 $\pm$ 0.2	120	0.50	300
CIA 31N 241	0.8 $\pm$ 0.2	240	0.80	200

Customized products are available.

Test equipment : Agilent 4291B+16192A

**Electrical Characteristics**

**CIA31U300**

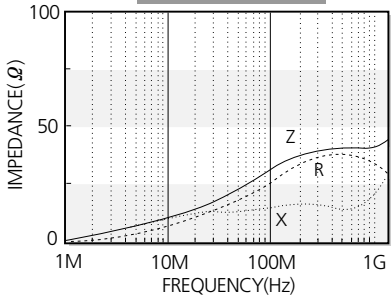

**CIA31U600**

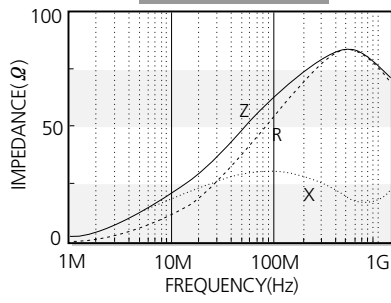

**CIA31U800**

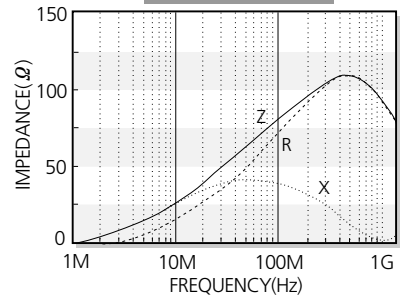

**CIA31U121**

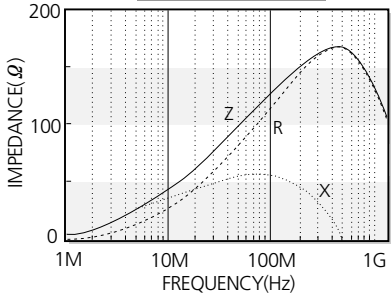

**CIA31U221**

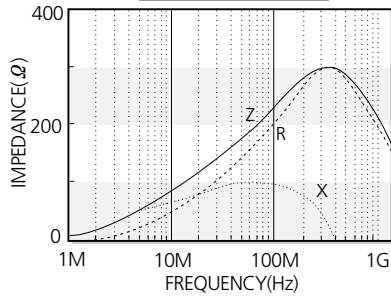

**CIA31U241**

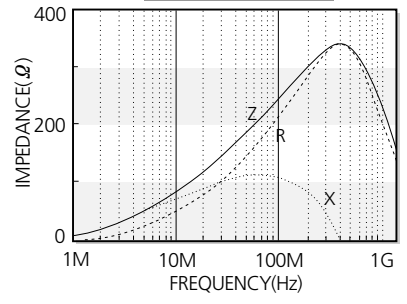

**CIA31U301**

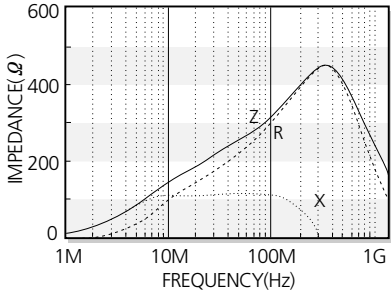

**CIA31U471**

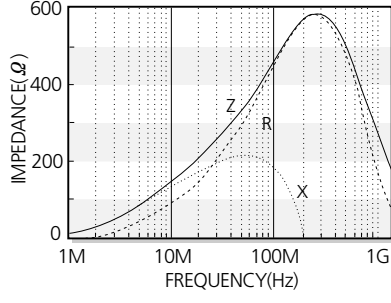

**CIA31U601**

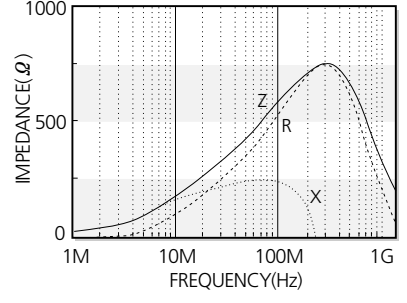

**CIA31U102**

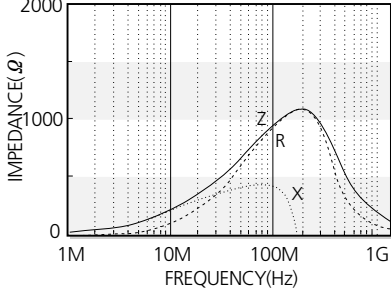

**CIA31J300**

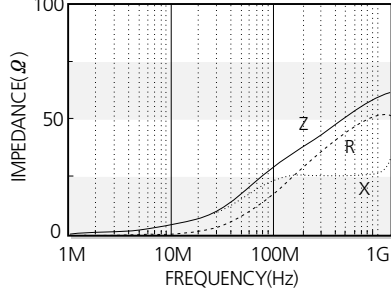

**CIA31J600**

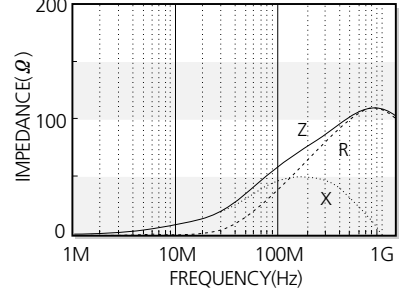

**CIA31J800**

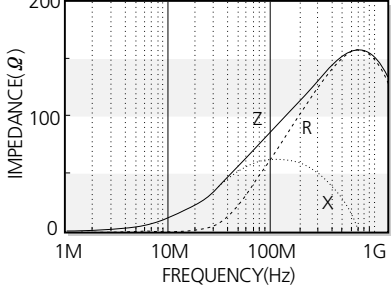

**CIA31J121**

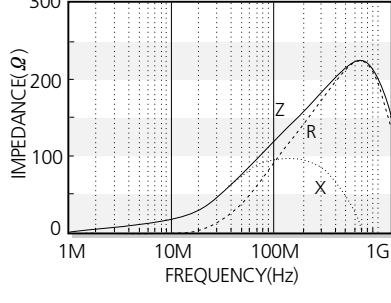

**CIA31J221**

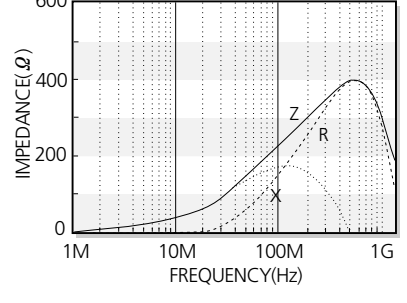

**CIA31J241**

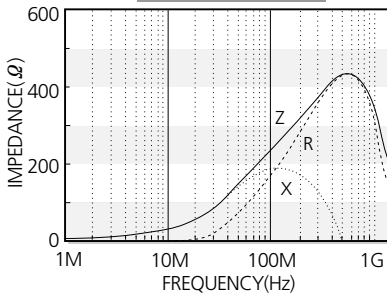

**CIA31J301**

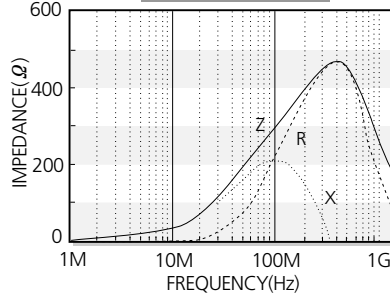

**CIA31J471**

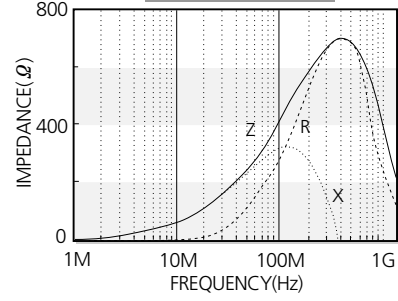

**CIA31J601**

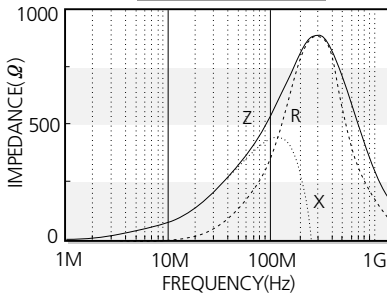

**CIA31J102**

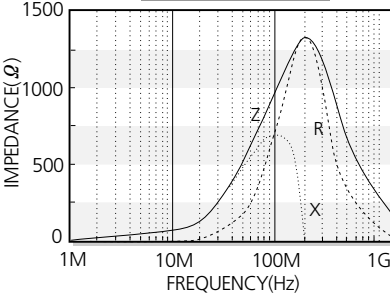

**CIA31N800**

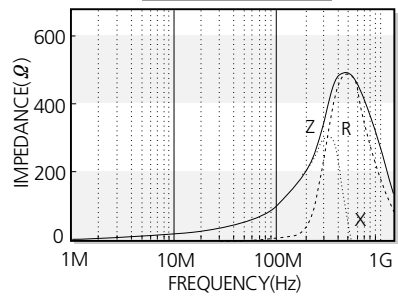

**CIA31N121**

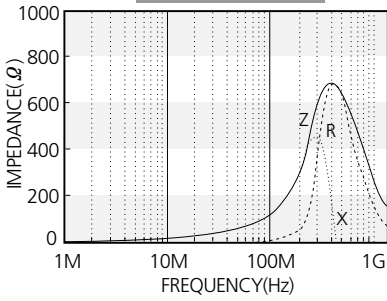

**CIA31N241**

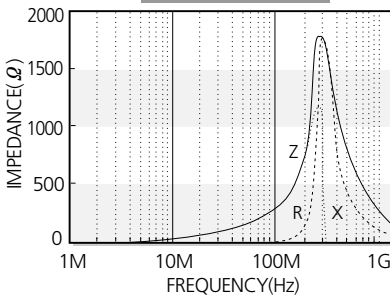



# Chip Bead ; CIC/CIS Series For High Current

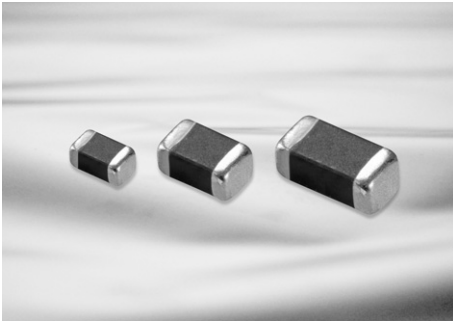

## Feature

- The smallest beads used for high current.  
(CIC: ~3A, CIS: ~6A)

## Application

- Suppression of noise in power line

The CIC/CIS Series can be used in high current owing to their low DC resistance. They can match power lines to a maximum of 6A DC.

Operating Temp	-55~+125°C
Storage Temp	-10~+40°C

## Dimensions

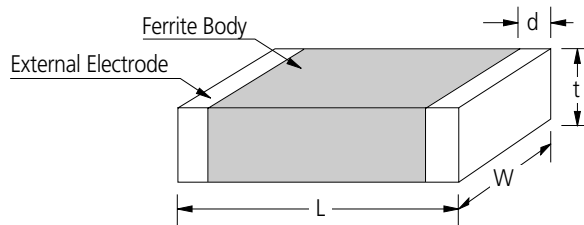

Unit : mm

SIZE CODE	L	W	t	d
05	1.0±0.05	0.5±0.05	0.5±0.05	0.25±0.1
10	1.6±0.15	0.8±0.15	0.8±0.15	0.3±0.2
21	2.0±0.2	1.25±0.2	0.9±0.2	0.5+0.2,-0.3
31	3.2±0.2	1.6±0.2	1.1±0.2	0.5+0.2,-0.3
32	3.2±0.2	2.5±0.2	1.3±0.2	0.5±0.3
41	4.5±0.2	1.6±0.2	1.6±0.2/1.2±0.2	0.5±0.3
43	4.5±0.2	3.2±0.2	1.5±0.2	0.5±0.3

## Part Numbering

**CI**   **C**   **05**   **P**   **300**   **N**   **C**  
 (1)   (2)   (3)   (4)   (5)   (6)   (7)

- (1) Chip Beads
- (2) C: For high current ~3A, S: Ultra high current ~6A
- (3) Dimension
- (4) Material Code(J, P)
- (5) Nominal impedance(310: 31Ω, 121: 120Ω)
- (6) Thickness option (N: Standard, A: Thinner than standard, B: Thicker than standard)
- (7) Packaging(C: paper tape, E: embossed tape)

### CIC 1005(0402) Type

Part No.	Thickness (mm)	Impedance ( $\Omega$ ) $\pm 25\%$ @ 100 MHz	DC Resistance ( $\Omega$ ) Max.	Rated Current (mA) Max.
CIC 05P 300	0.50 $\pm$ 0.05	30	0.05	1500
CIC 05P 600	0.50 $\pm$ 0.05	60	0.09	1500
CIC 05P 121	0.50 $\pm$ 0.05	120	0.09	1500
CIC 05J 600	0.50 $\pm$ 0.05	60	0.09	1500

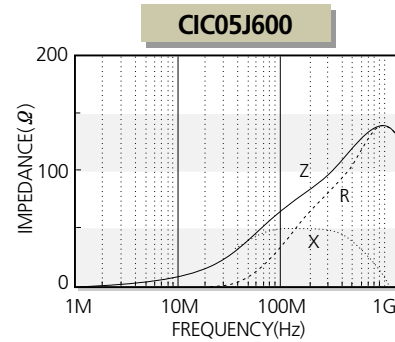
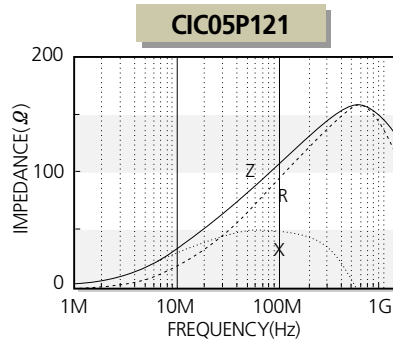
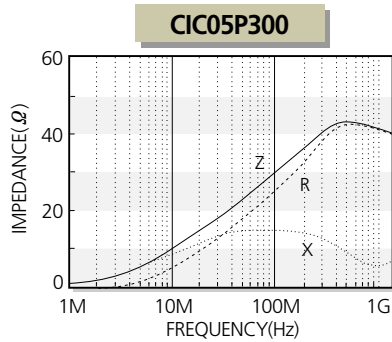

### CIC 1608(0603) Type

Part No.	Thickness (mm)	Impedance ( $\Omega$ ) $\pm 25\%$ @ 100 MHz	DC Resistance ( $\Omega$ ) Max.	Rated Current (mA) Max.
CIC 10P 080	0.80 $\pm$ 0.15	8	0.02	3000
CIC 10P 220	0.80 $\pm$ 0.15	22	0.025	3000
CIC 10P 300	0.80 $\pm$ 0.15	30	0.025	3000
CIC 10P 600	0.80 $\pm$ 0.15	60	0.05	2000
CIC 10P 121	0.80 $\pm$ 0.15	120	0.05	2000
CIC 10P 181	0.80 $\pm$ 0.15	180	0.09	1500
CIC 10P 221	0.80 $\pm$ 0.15	220	0.09	1000
CIC 10P 301	0.80 $\pm$ 0.15	300	0.15	750
CIC 10P 331	0.80 $\pm$ 0.15	330	0.15	1200
CIC 10J 080	0.80 $\pm$ 0.15	8	0.02	3000
CIC 10J 300	0.80 $\pm$ 0.15	30	0.03	2000
CIC 10J 600	0.80 $\pm$ 0.15	60	0.05	2000
CIC 10J 121	0.80 $\pm$ 0.15	120	0.05	2000
CIC 10J 221	0.80 $\pm$ 0.15	220	0.10	1500
CIC 10J 301	0.80 $\pm$ 0.15	300	0.15	800
CIC 10J 471	0.80 $\pm$ 0.15	470	0.15	800
CIC 10J 601	0.80 $\pm$ 0.15	600	0.15	750

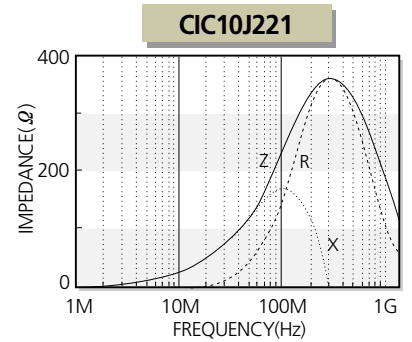
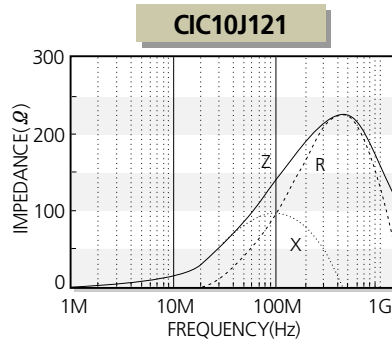
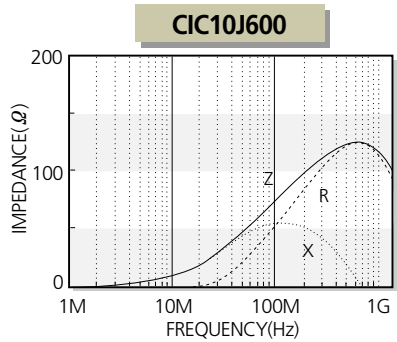
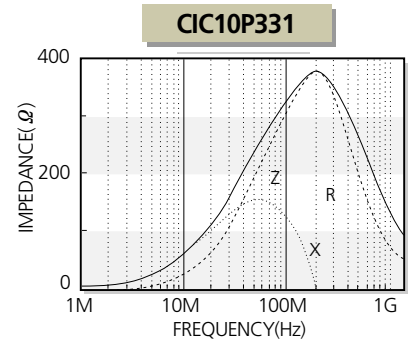
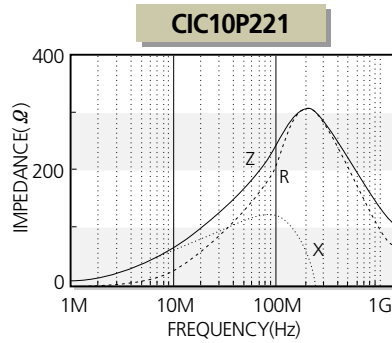
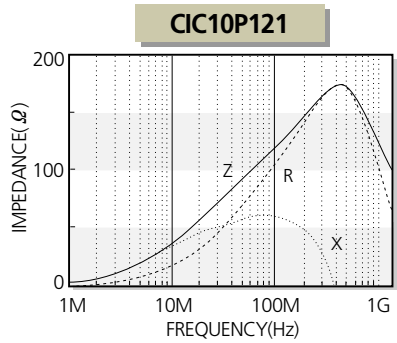
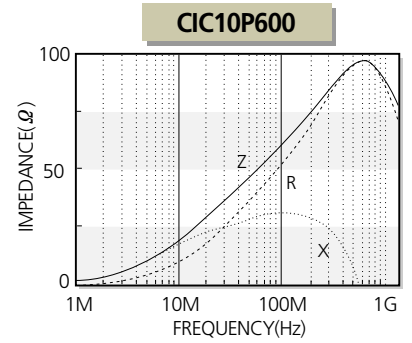
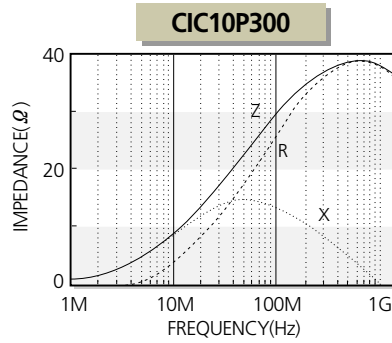
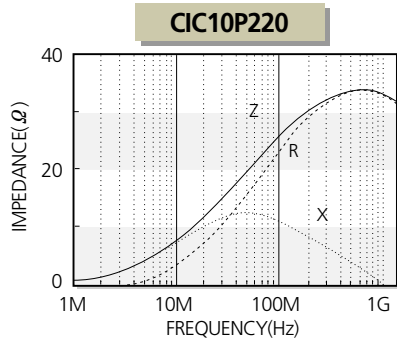

**CIC 2012(0805) Type**

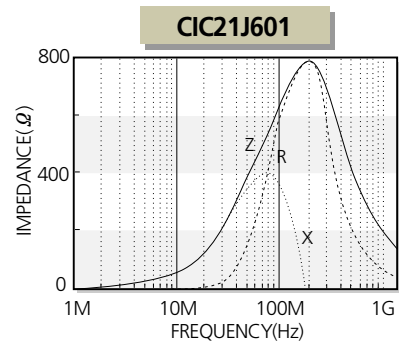
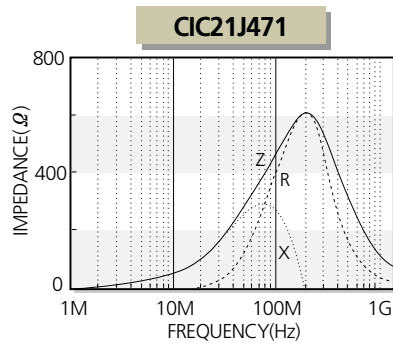
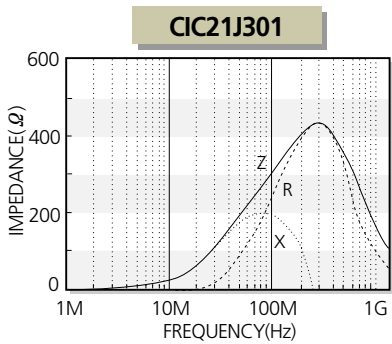
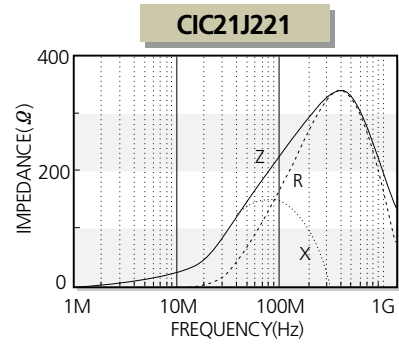
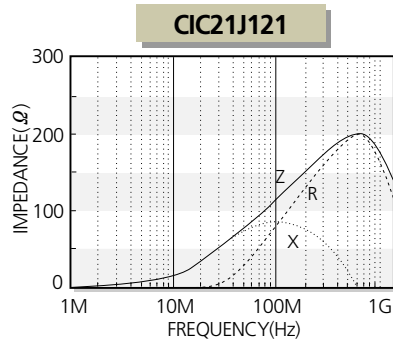
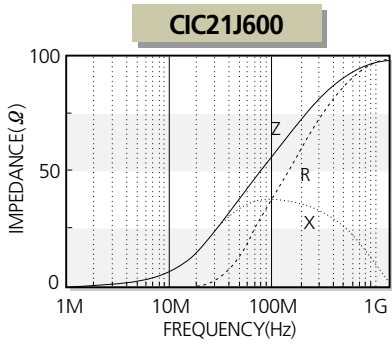
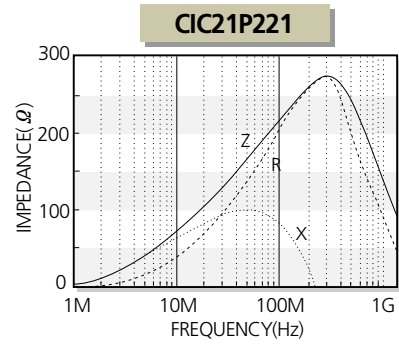
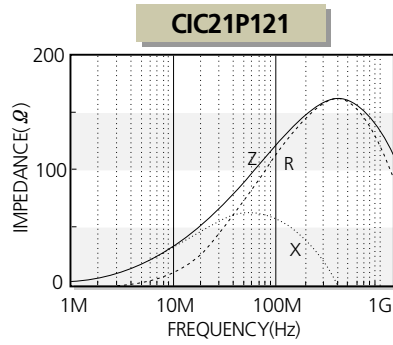
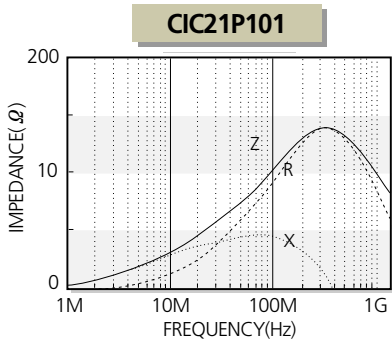
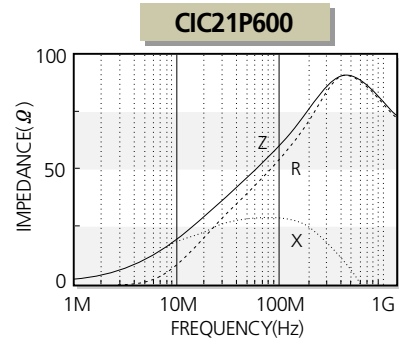
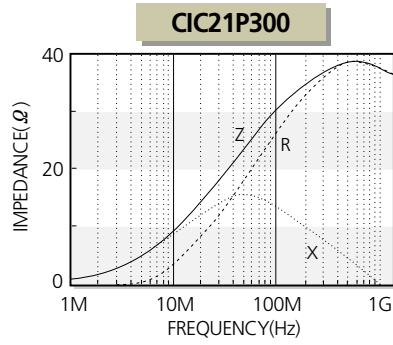
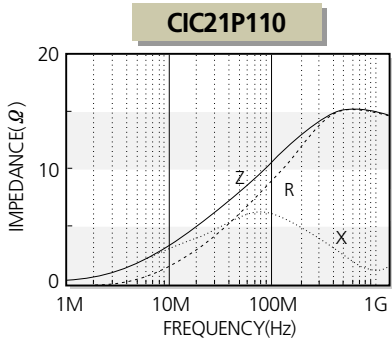
Part No.	Thickness (mm)	Impedance ( $\Omega$ ) $\pm 25\%$ @ 100 MHz	DC Resistance ( $\Omega$ ) Max.	Rated Current (mA) Max.
CIC 21P 110	0.90 $\pm$ 0.2	11	0.01	3000
CIC 21P 300	0.90 $\pm$ 0.2	30	0.015	3000
CIC 21P 600	0.90 $\pm$ 0.2	60	0.025	3000
CIC 21P 101	0.90 $\pm$ 0.2	100	0.04	2000
CIC 21P 121	0.90 $\pm$ 0.2	120	0.05	2000
CIC 21P 221	0.90 $\pm$ 0.2	220	0.05	2000
CIC 21J 600	0.90 $\pm$ 0.2	60	0.03	2500
CIC 21J 121	0.90 $\pm$ 0.2	120	0.05	2500
CIC 21J 221	0.90 $\pm$ 0.2	220	0.05	1500
CIC 21J 301	0.90 $\pm$ 0.2	300	0.10	1500
CIC 21J 471	0.90 $\pm$ 0.2	470	0.08	1500
CIC 21J 601	0.90 $\pm$ 0.2	600	0.15	1000

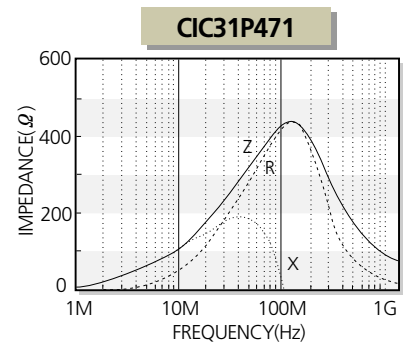
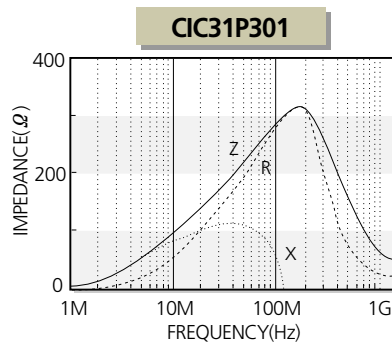
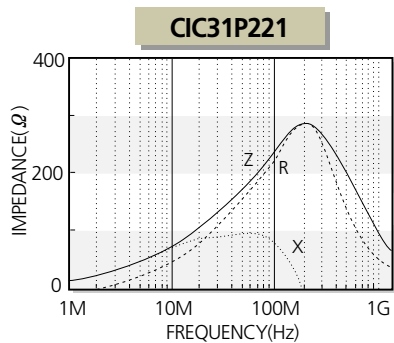
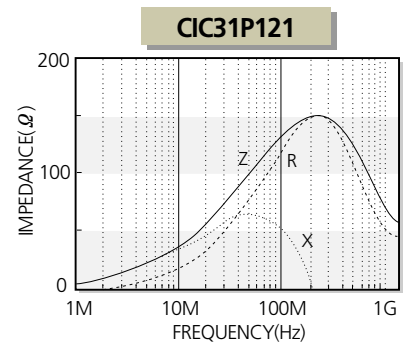
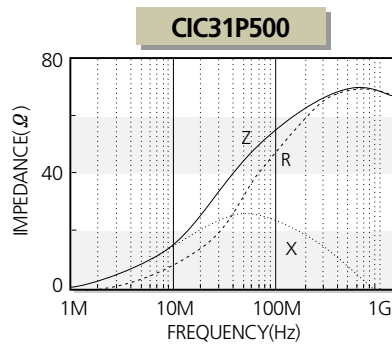
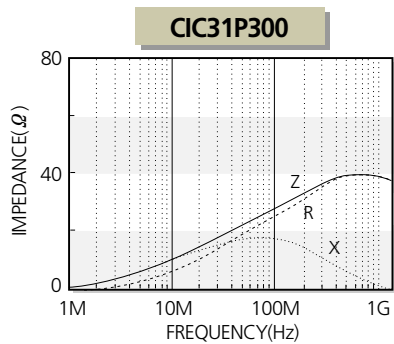

**CIC 3216(1206) Type**

Part No.	Thickness (mm)	Impedance ( $\Omega$ ) $\pm 25\%$ @ 100 MHz	DC Resistance ( $\Omega$ ) Max.	Rated Current (mA) Max.
CIC 31P 300	1.1 $\pm$ 0.2	30	0.01	3000
CIC 31P 500	1.1 $\pm$ 0.2	50	0.025	3000
CIC 31P 700	1.1 $\pm$ 0.2	70	0.025	3000
CIC 31P 121	1.1 $\pm$ 0.2	120	0.025	2000
CIC 31P 221	1.1 $\pm$ 0.2	220	0.05	2000
CIC 31P 301	1.1 $\pm$ 0.2	300	0.05	2000
CIC 31P 471	1.1 $\pm$ 0.2	470	0.07	1500
CIC 31P 601	1.1 $\pm$ 0.2	600	0.15	1000
CIC 31J 300	1.1 $\pm$ 0.2	30	0.02	4000
CIC 31J 500	1.1 $\pm$ 0.2	50	0.02	4000
CIC 31J 800	1.1 $\pm$ 0.2	80	0.02	4000
CIC 31J 121	1.1 $\pm$ 0.2	120	0.03	4000
CIC 31J 241	1.1 $\pm$ 0.2	240	0.05	3000
CIC 31J 301	1.1 $\pm$ 0.2	300	0.05	3000
CIC 31J 471	1.1 $\pm$ 0.2	470	0.05	3000
CIC 31J 601	1.1 $\pm$ 0.2	600	0.05	2500



**CIC31P500**

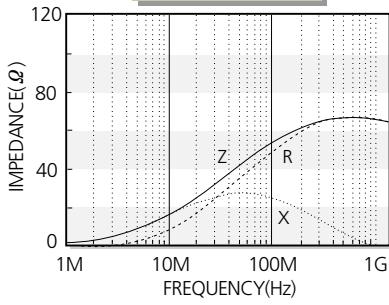

**CIC31P601**

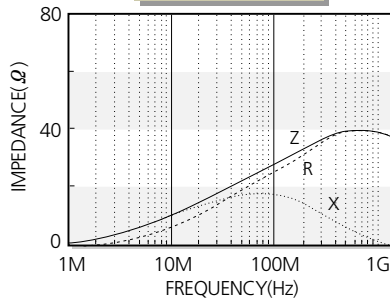

**CIC31J300**

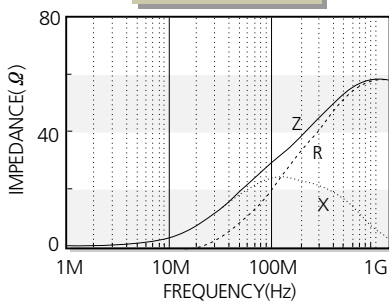

**CIC31J500**

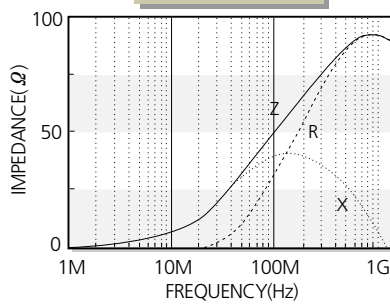

**CIC31J800**

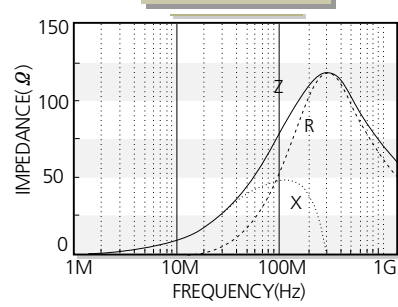

**CIC31J121**

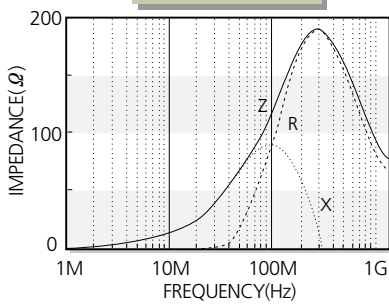

**CIC31J241**

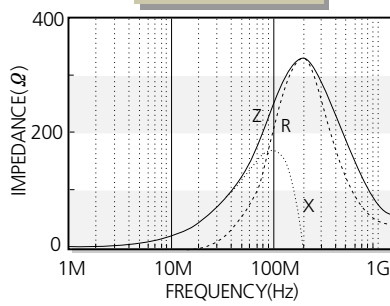

**CIC31J301**

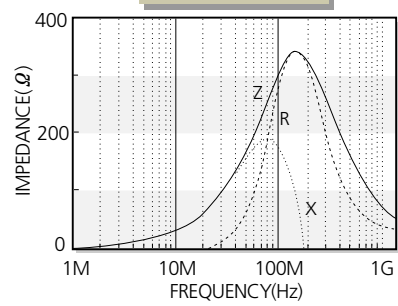

**CIC31J471**

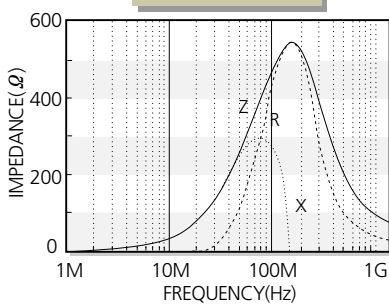

**CIC31J601**

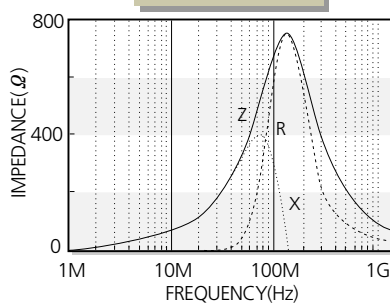

**CIC 4516(1806) Type**

Part No.	Thickness (mm)	Impedance ( $\Omega$ ) $\pm 25\%$ @ 100 MHz	DC Resistance ( $\Omega$ ) Max.	Rated Current (mA) Max.
CIC 41P 800	1.6 $\pm$ 0.2	80	0.01	3000
CIC 41P 121	1.6 $\pm$ 0.2	120	0.025	3000
CIC 41P 221	1.6 $\pm$ 0.2	220	0.05	2000
CIC 41P 301	1.6 $\pm$ 0.2	300	0.05	2000
CIC 41P 471	1.6 $\pm$ 0.2	470	0.05	2000
CIC 41P 601	1.6 $\pm$ 0.2	600	0.08	1500
CIC 41J 400	1.6 $\pm$ 0.2	40	0.01	3000
CIC 41J 800	1.6 $\pm$ 0.2	80	0.01	3000
CIC 41J 121	1.6 $\pm$ 0.2	120	0.03	3000
CIC 41J 221	1.6 $\pm$ 0.2	220	0.04	2500
CIC 41J 301	1.6 $\pm$ 0.2	300	0.04	2500
CIC 41J 471	1.6 $\pm$ 0.2	470	0.04	2500
CIC 41J 601	1.6 $\pm$ 0.2	600	0.04	2500

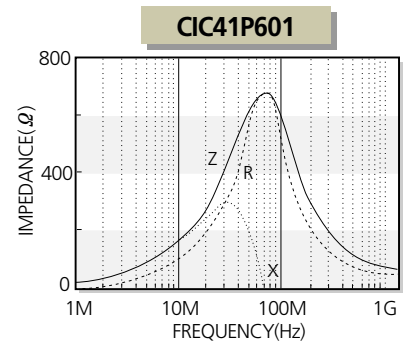
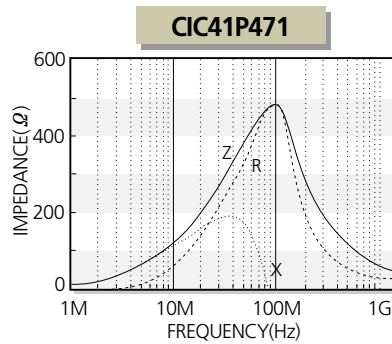
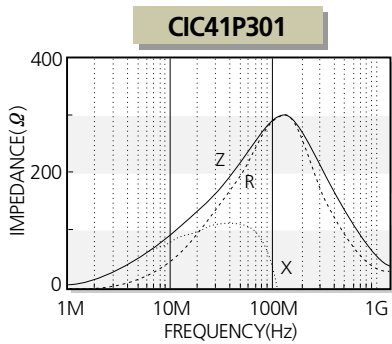
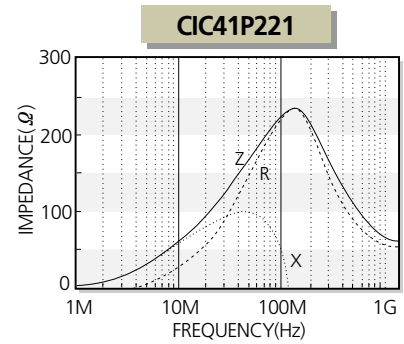
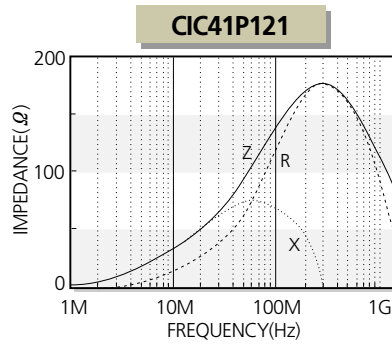
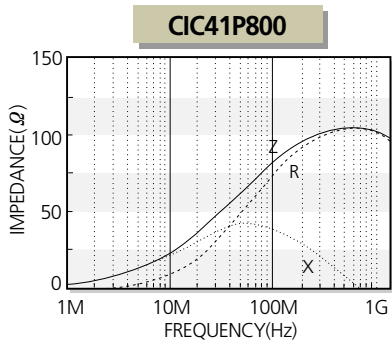

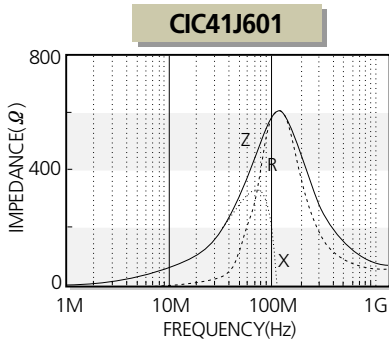
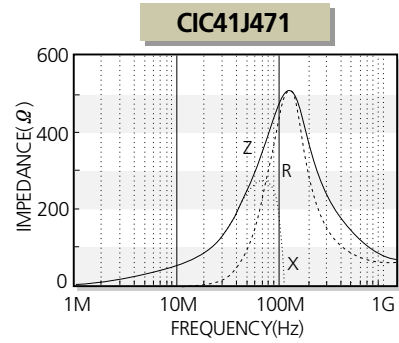
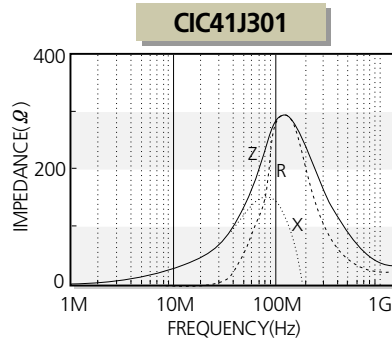
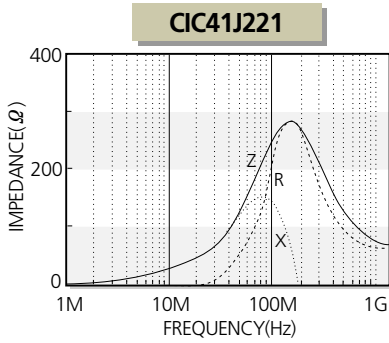
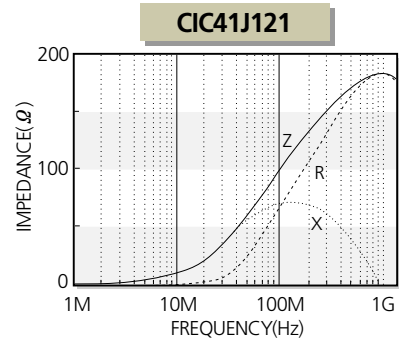
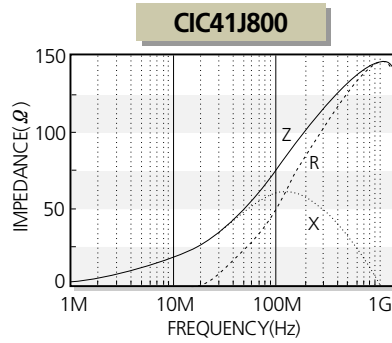
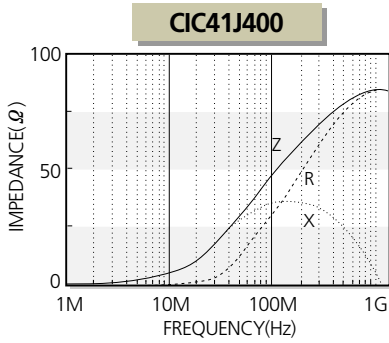

**CIC 4532(1812) Type**

Part No.	Thickness (mm)	Impedance (Ω) ±25% @ 100 MHz	DC Resistance (Ω) Max.	Rated Current (mA) Max.
CIC 43P 300	1.5±0.2	30	0.03	3000
CIC 43P 700	1.5±0.2	70	0.03	3000
CIC 43P 121	1.5±0.2	120	0.03	3000
CIC 43P 221	1.5±0.2	220	0.05	2000
CIC 43P 301	1.5±0.2	300	0.05	2000
CIC 43P 471	1.5±0.2	470	0.05	2000
CIC 43P 601	1.5±0.2	600(at 50MHz)	0.05	3000
CIC 43J 300	1.5±0.2	30	0.02	3000
CIC 43J 121	1.5±0.2	120	0.03	3000
CIC 43J 301	1.5±0.2	300	0.04	3000
CIC 43J 471	1.5±0.2	470	0.04	3000
CIC 43J 601	1.5±0.2	600	0.04	3000



**CIC43P300**

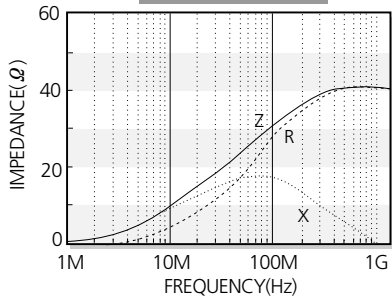

**CIC43P700**

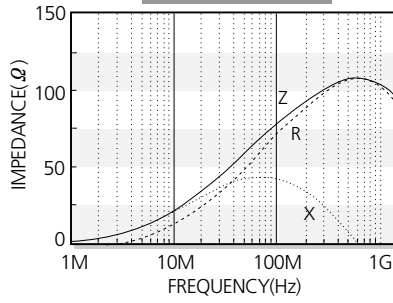

**CIC43P121**

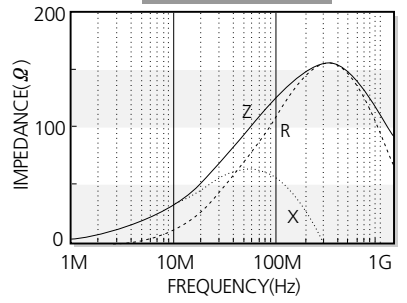

**CIC43P221**

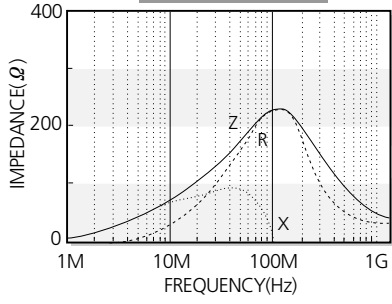

**CIC43P301**

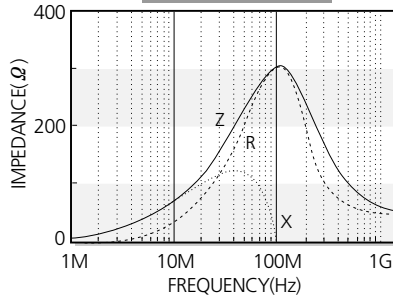

**CIC43P471**

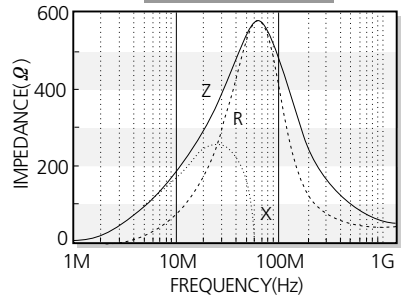

**CIC43P601**

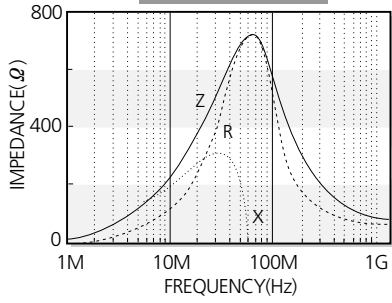

**CIC43J300**

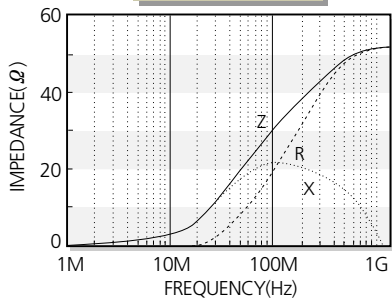

**CIC43J121**

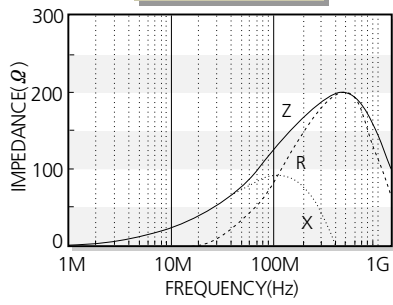

**CIC43J301**

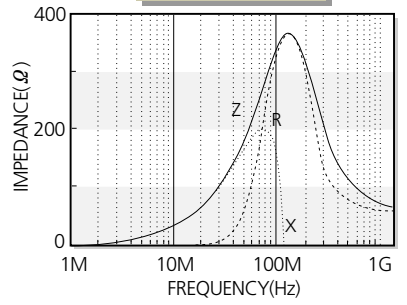

**CIC43J471**

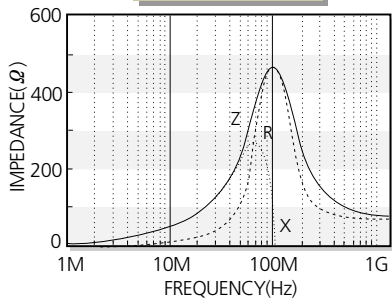

**CIC43J601**

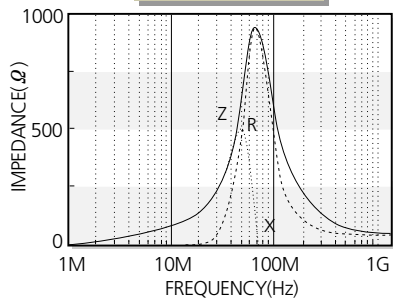

CIS Series

Part No.	Thickness (mm)	Impedance ( $\Omega$ ) $\pm 25\%$ @ 100 MHz	DC Resistance ( $\Omega$ ) Max.	Rated Current (mA) Max.
CIS 10P 260	0.6 $\pm$ 0.15	26	0.007	6000
CIS 10J 300	0.8 $\pm$ 0.15	30	0.01	6000
CIS 21P 300	0.9 $\pm$ 0.2	30	0.01	5000
CIS 21J 121	0.9 $\pm$ 0.2	120	0.02	5000
CIS 32P 520	1.3 $\pm$ 0.2	52	0.01	6000
CIS 32J 121	1.3 $\pm$ 0.2	120	0.02	5000
CIS 41P 600	1.6 $\pm$ 0.2/1.2 $\pm$ 0.2	60	0.01	6000
CIS 41J 600	1.6 $\pm$ 0.2/1.2 $\pm$ 0.2	60	0.01	6000
CIS 43J 121	1.5 $\pm$ 0.2	120	0.02	6000
CIS 43P 241	1.5 $\pm$ 0.2	240	0.02	6000

Customized products are available.

Test equipment : Agilent 4291B+16192A (1005)

Agilent 4291B+16193A (1608 and others)

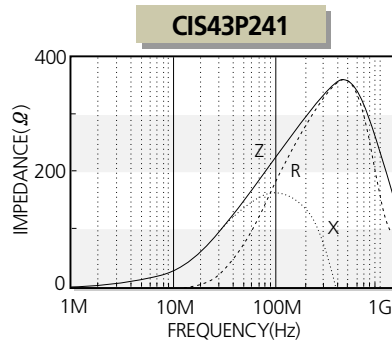
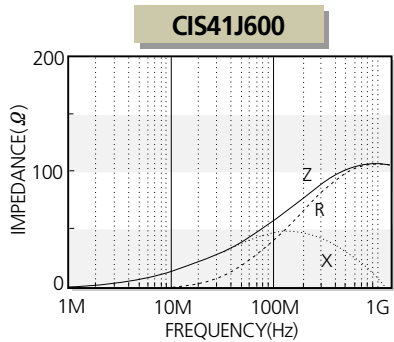
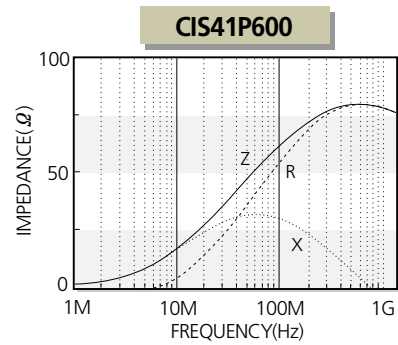
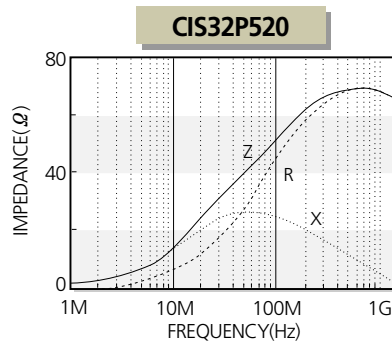
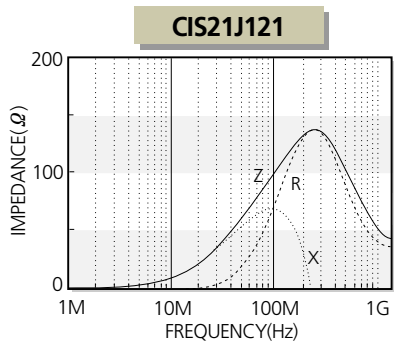
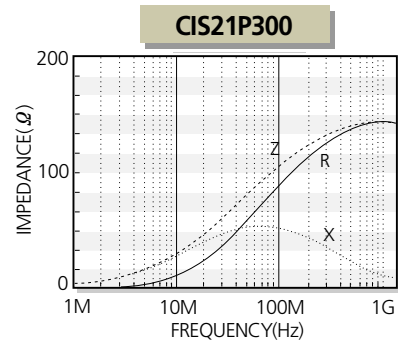
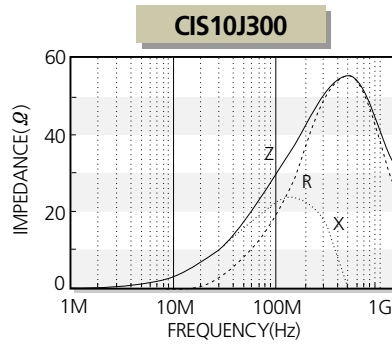
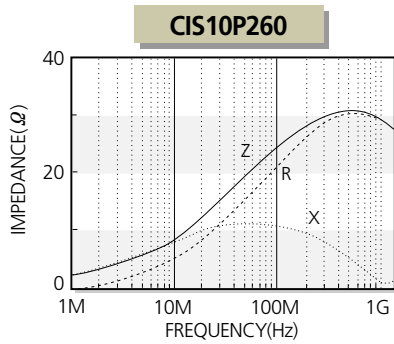

# CIV Series

## GHz noise suppression

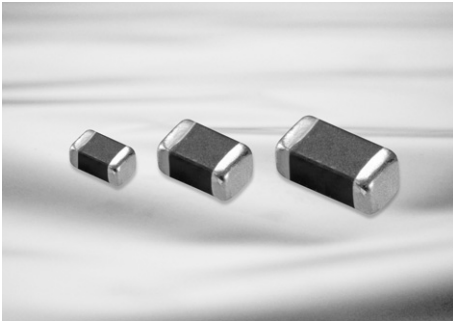

### Feature

- CIV Series have high impedance in a GHz band and suppress GHz noise
- Small beads suitable for surface mounting
- Excellent solderability and high heat resistance for either flow or reflow soldering

### Application

- High frequency EMI prevention application to computers, printers, VCRs, TVs and mobile phones.

Operating Temp	-55~+125°C
Storage Temp	-10~+40°C

### Dimensions

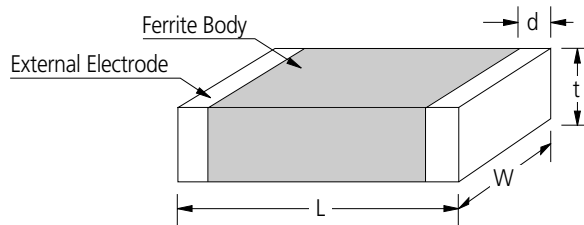

Unit : mm

SIZE CODE	L	W	t	d
05	1.0±0.05	0.5±0.05	0.5±0.05	0.25±0.1

### Part Numbering

**CI V 05 U 102 N C**  
 (1) (2) (3) (4) (5) (6) (7)

- (1) Chip Beads
- (2) V: For GHz Noise Suppression
- (3) Dimension
- (4) Material Code (U,J)
- (5) Nominal impedance (601:600 Ω 102:1000 Ω,)
- (6) Thickness option (N: Standard, A: Thinner than standard, B: Thicker than standard)
- (7) Packaging (C: paper tape, E: embossed tape)

CIV 1005(0402)Type

Part No.	Thickness (mm)	Impedance ( $\Omega$ ) $\pm$ 25% @ 100 MHz	Impedance ( $\Omega$ ) $\pm$ 40% @ 1 GHz	DC Resistance ( $\Omega$ ) Max.	Rated Current (mA) Max.
CIV05U601	0.5 $\pm$ 0.05	600	1000	0.7	300
CIV05U102	0.5 $\pm$ 0.05	1000	1400	1.1	250
CIV05J102	0.5 $\pm$ 0.05	1000	2000	1.25	250
CIV05J182	0.5 $\pm$ 0.05	1800	2700	2.20	200

CIV05U601NC

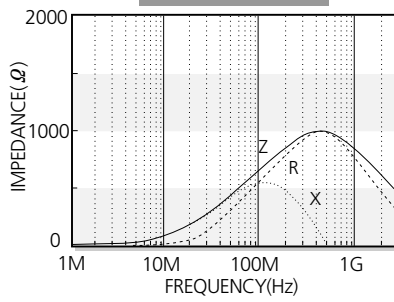

CIV05U102NC

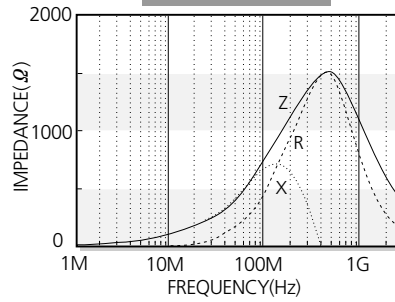

CIV05J102NC

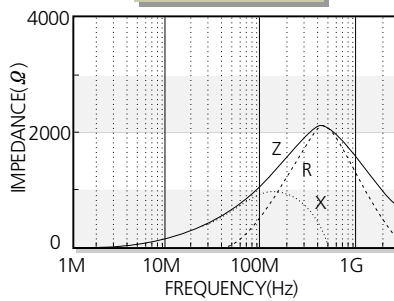

CIV05J182NC

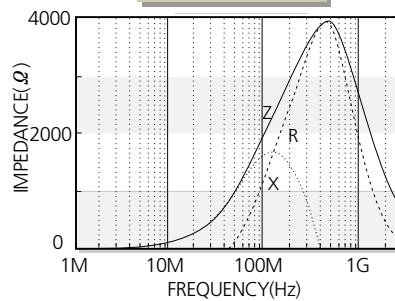

CIV Series

# Chip Inductor; CIL Series General Type



## Feature

- Magnetic shielding eliminates crosstalk, thus permitting higher mounting density.
- Excellent solderability and high heat resistance for either flow or reflow soldering.
- Monolithic structure for high reliability.

## Application

- Resonance circuits, PLL circuits, Noise suppression, etc.

As it has ferrite body and 100 % Ag internal conductor, the CIL series Inductors have excellent Q characteristics and free of cross talk.

Operating Temp	-55~+125°C
Storage Temp	-10~+40°C

## Dimensions

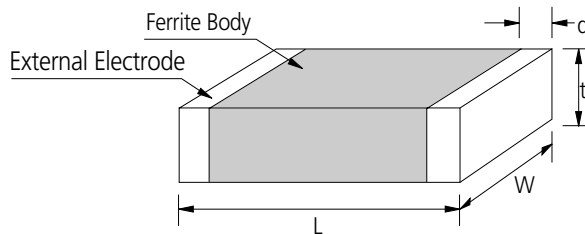

Unit : mm

SIZE CODE	L	W	T	d
05	1.0±0.05	0.5±0.05	0.5±0.05	0.25±0.1
10	1.6±0.15	0.8±0.15	0.8±0.15	0.3±0.2
21	2.0±0.2	1.25±0.2	0.85±0.2 1.25±0.2	0.5+0.2,-0.3
31	3.2±0.2	1.6±0.2	0.6±0.2 1.1±0.2	0.5+0.2,-0.3

## Part Numbering

**CI**   **L**   **10**   **Y**   **5R6**   **K**   **N**   **C**  
 (1)   (2)   (3)   (4)   (5)   (6)   (7)   (8)

- (1) Chip Inductor
- (2) L:General Type
- (3) Dimension
- (4) Material code(N, J, Y, S)
- (5) Inductance(R10:0.1μH, 5R6:5.6μH, 100:10μH)
- (6) Tolerance(K: ±10%, M: ±20%)
- (7) Thickness option(N:Standard, A:Thinner than standard, B:Thicker than standard)
- (8) Packaging(C:paper tape, E:embossed tape)

**CIL 1005(0402) Type**

Part No.	Thickness (mm)	Inductance ( $\mu\text{H}$ )	Q Min.	L, Q test frequency (MHZ)	SRF (MHZ) Min.	DC resistance ( $\Omega$ ) Max.	Rated current (mA) Max.
CIL 05J 2R2 □	0.5±0.05	2.2±20%, 10%	20	10	40	1.70	10

**CIL 1608(0603) Type**

Part No.	Thickness (mm)	Inductance ( $\mu\text{H}$ )	Q Min.	L, Q test frequency (MHZ)	SRF (MHZ) Min.	DC resistance ( $\Omega$ ) Max.	Rated current (mA) Max.
CIL 10N 47N □	0.80±0.15	0.047±20%, 10%	10	50	260	0.30	50
CIL 10N 56N □	0.80±0.15	0.056±20%, 10%	10	50	260	0.30	50
CIL 10N 68N □	0.80±0.15	0.068±20%, 10%	10	50	250	0.30	50
CIL 10N 82N □	0.80±0.15	0.082±20%, 10%	10	50	245	0.30	50
CIL 10N R10 □	0.80±0.15	0.10±20%, 10%	15	25	240	0.50	50
CIL 10N R12 □	0.80±0.15	0.12±20%, 10%	15	25	205	0.50	50
CIL 10N R15 □	0.80±0.15	0.15±20%, 10%	15	25	180	0.60	50
CIL 10N R18 □	0.80±0.15	0.18±20%, 10%	15	25	165	0.60	50
CIL 10N R22 □	0.80±0.15	0.22±20%, 10%	15	25	150	0.80	50
CIL 10N R27 □	0.80±0.15	0.27±20%, 10%	15	25	136	0.80	50
CIL 10N R33 □	0.80±0.15	0.33±20%, 10%	15	25	125	0.85	35
CIL 10N R39 □	0.80±0.15	0.39±20%, 10%	15	25	110	1.00	35
CIL 10N R47 □	0.80±0.15	0.47±20%, 10%	15	25	105	1.35	35
CIL 10N R56 □	0.80±0.15	0.56±20%, 10%	15	25	95	1.55	35
CIL 10N R68 □	0.80±0.15	0.68±20%, 10%	15	25	80	1.70	35
CIL 10N R82 □	0.80±0.15	0.82±20%, 10%	15	25	75	2.10	35
CIL 10J 1R0 □	0.80±0.15	1.0±20%, 10%	35	10	70	0.60	25
CIL 10J 1R2 □	0.80±0.15	1.2±20%, 10%	35	10	60	0.80	25
CIL 10J 1R5 □	0.80±0.15	1.5±20%, 10%	35	10	55	0.80	25
CIL 10J 1R8 □	0.80±0.15	1.8±20%, 10%	35	10	50	0.95	25
CIL 10J 2R2 □	0.80±0.15	2.2±20%, 10%	35	10	45	1.15	15
CIL 10J 2R7 □	0.80±0.15	2.7±20%, 10%	35	10	40	1.35	15
CIL 10J 3R3 □	0.80±0.15	3.3±20%, 10%	35	10	38	1.55	15
CIL 10J 3R9 □	0.80±0.15	3.9±20%, 10%	35	10	36	1.70	15
CIL 10J 4R7 □	0.80±0.15	4.7±20%, 10%	35	10	33	2.10	15
CIL 10Y 5R6 □	0.80±0.15	5.6±20%, 10%	35	4	22	1.55	5
CIL 10Y 6R8 □	0.80±0.15	6.8±20%, 10%	35	4	20	1.70	5
CIL 10Y 8R2 □	0.80±0.15	8.2±20%, 10%	35	4	18	2.10	5
CIL 10Y 100 □	0.80±0.15	10.0±20%, 10%	35	2	17	2.55	5
CIL 10Y 120 □	0.80±0.15	12.0±20%, 10%	35	2	15	2.75	5
CIL 10S 150 □	0.80±0.15	15.0±20%, 10%	20	1	14	1.70	1
CIL 10S 180 □	0.80±0.15	18.0±20%, 10%	20	1	13	1.85	1
CIL 10S 220 □	0.80±0.15	22.0±20%, 10%	20	1	11	2.10	1
CIL 10S 270 □	0.80±0.15	27.0±20%, 10%	20	1	10	2.75	1
CIL 10S 330 □	0.80±0.15	33.0±20%, 10%	20	0.4	9	2.95	1

□: Tolerance (K: ±10%, M: ±20%)

\* Test equipment: Agilent 4291B+16193A

**CIL 2012(0805) Type**

Part No.	Thickness (mm)	Inductance ( $\mu$ H)	Q Min.	L, Q test frequency (MHZ)	SRF (MHZ) Min.	DC resistance ( $\Omega$ ) Max.	Rated current (mA) Max.
CIL 21N 47N □	0.85±0.2	0.047±20%, 10%	15	50	320	0.20	300
CIL 21N 68N □	0.85±0.2	0.068±20%, 10%	15	50	280	0.20	300
CIL 21N 82N □	0.85±0.2	0.082±20%, 10%	15	50	255	0.20	300
CIL 21N R10 □	0.85±0.2	0.10±20%, 10%	20	25	235	0.20	250
CIL 21N R12 □	0.85±0.2	0.12±20%, 10%	20	25	220	0.20	250
CIL 21N R15 □	0.85±0.2	0.15±20%, 10%	20	25	200	0.25	250
CIL 21N R18 □	0.85±0.2	0.18±20%, 10%	20	25	185	0.25	250
CIL 21N R22 □	0.85±0.2	0.22±20%, 10%	20	25	170	0.30	250
CIL 21N R27 □	0.85±0.2	0.27±20%, 10%	20	25	150	0.30	250
CIL 21N R33 □	0.85±0.2	0.33±20%, 10%	20	25	145	0.30	250
CIL 21N R39 □	0.85±0.2	0.39±20%, 10%	25	25	135	0.40	200
CIL 21N R47 □	1.25±0.2	0.47±20%, 10%	25	25	125	0.40	200
CIL 21N R56 □	1.25±0.2	0.56±20%, 10%	25	25	115	0.50	150
CIL 21N R68 □	1.25±0.2	0.68±20%, 10%	25	25	105	0.50	150
CIL 21N R82 □	1.25±0.2	0.82±20%, 10%	25	25	100	0.60	150
CIL 21J 1R0 □	0.85±0.2	1.0±20%, 10%	45	10	75	0.30	50
CIL 21J 1R2 □	0.85±0.2	1.2±20%, 10%	45	10	65	0.40	50
CIL 21J 1R5 □	0.85±0.2	1.5±20%, 10%	45	10	60	0.40	50
CIL 21J 1R8 □	0.85±0.2	1.8±20%, 10%	45	10	55	0.40	50
CIL 21J 2R2 □	0.85±0.2	2.2±20%, 10%	45	10	50	0.50	30
CIL 21J 2R7 □	1.25±0.2	2.7±20%, 10%	45	10	45	0.60	30
CIL 21J 3R3 □	1.25±0.2	3.3±20%, 10%	45	10	41	0.60	30
CIL 21J 3R9 □	1.25±0.2	3.9±20%, 10%	45	10	38	0.80	30
CIL 21J 4R7 □	1.25±0.2	4.7±20%, 10%	45	10	35	0.90	30
CIL 21Y 5R6 □	1.25±0.2	5.6±20%, 10%	50	4	32	0.50	25
CIL 21Y 6R8 □	1.25±0.2	6.8±20%, 10%	50	4	29	0.60	15
CIL 21Y 8R2 □	1.25±0.2	8.2±20%, 10%	50	4	26	0.70	15
CIL 21Y 100 □	1.25±0.2	10.0±20%, 10%	50	2	24	0.80	15
CIL 21Y 120 □	1.25±0.2	12.0±20%, 10%	50	2	22	0.90	15
CIL 21S 150 □	1.25±0.2	15.0±20%, 10%	30	1	19	0.80	5
CIL 21S 180 □	1.25±0.2	18.0±20%, 10%	30	1	18	0.90	5
CIL 21S 220 □	1.25±0.2	22.0±20%, 10%	30	1	16	1.10	5
CIL 21S 270 □	1.25±0.2	27.0±20%, 10%	30	1	14	1.15	5
CIL 21S 330 □	1.25±0.2	33.0±20%, 10%	30	0.4	13	1.25	5

□: Tolerance (K: ±10%, M: ±20%)

※ Test equipment: Agilent 4291B+16193A

CIL 3216(1206) Type

Part No.	Thickness (mm)	Inductance ( $\mu$ H)	Q Min.	L, Q test frequency (MHZ)	SRF (MHZ) Min.	DC resistance ( $\Omega$ ) Max.	Rated current (mA) Max.
CIL 31N 47N□	0.6±0.2	0.047±20%, 10%	20	50	320	0.15	300
CIL 31N 68N□	0.6±0.2	0.068±20%, 10%	20	50	280	0.25	300
CIL 31N R10□	0.6±0.2	0.10±20%, 10%	20	25	235	0.25	250
CIL 31N R12□	0.6±0.2	0.12±20%, 10%	20	25	220	0.30	250
CIL 31N R15□	0.6±0.2	0.15±20%, 10%	20	25	200	0.30	250
CIL 31N R18□	0.6±0.2	0.18±20%, 10%	20	25	185	0.40	250
CIL 31N R22□	0.6±0.2	0.22±20%, 10%	20	25	170	0.40	250
CIL 31N R27□	0.6±0.2	0.27±20%, 10%	20	25	150	0.50	250
CIL 31N R33□	0.6±0.2	0.33±20%, 10%	20	25	145	0.60	250
CIL 31N R39□	1.1±0.2	0.39±20%, 10%	25	25	135	0.50	200
CIL 31N R47□	1.1±0.2	0.47±20%, 10%	25	25	125	0.60	200
CIL 31N R56□	1.1±0.2	0.56±20%, 10%	25	25	115	0.70	150
CIL 31N R68□	1.1±0.2	0.68±20%, 10%	25	25	105	0.80	150
CIL 31N R82□	1.1±0.2	0.82±20%, 10%	25	25	100	0.90	150
CIL 31J 1R0□	0.6±0.2	1.0±20%, 10%	45	10	75	0.40	100
CIL 31J 1R2□	0.6±0.2	1.2±20%, 10%	45	10	65	0.50	100
CIL 31J 1R5□	1.1±0.2	1.5±20%, 10%	45	10	60	0.50	50
CIL 31J 1R8□	1.1±0.2	1.8±20%, 10%	45	10	55	0.50	50
CIL 31J 2R2□	1.1±0.2	2.2±20%, 10%	45	10	50	0.60	50
CIL 31J 2R7□	1.1±0.2	2.7±20%, 10%	45	10	45	0.60	50
CIL 31J 3R3□	1.1±0.2	3.3±20%, 10%	45	10	41	0.70	50
CIL 31J 3R9□	1.1±0.2	3.9±20%, 10%	45	10	38	0.80	50
CIL 31J 4R7□	1.1±0.2	4.7±20%, 10%	45	10	35	0.90	50
CIL 31Y 5R6□	1.1±0.2	5.6±20%, 10%	50	4	32	0.70	25
CIL 31Y 6R8□	1.1±0.2	6.8±20%, 10%	50	4	29	0.80	25
CIL 31Y 8R2□	1.1±0.2	8.2±20%, 10%	50	4	26	0.90	25
CIL 31Y 100□	1.1±0.2	10.0±20%, 10%	50	2	24	1.00	25
CIL 31Y 120□	1.1±0.2	12.0±20%, 10%	50	2	22	1.05	15
CIL 31S 150□	1.1±0.2	15.0±20%, 10%	35	1	19	0.70	5
CIL 31S 180□	1.1±0.2	18.0±20%, 10%	35	1	18	0.70	5
CIL 31S 220□	1.1±0.2	22.0±20%, 10%	35	1	16	0.90	5
CIL 31S 270□	1.1±0.2	27.0±20%, 10%	35	1	14	0.90	5
CIL 31S 330□	1.1±0.2	33.0±20%, 10%	35	0.4	13	1.05	5

□: Tolerance (K: ±10%, M: ±20%)  
 ※ Test equipment: Agilent 4291B+16193A



**CIL 1005(0402) Type**

■ **IMPEDANCE CHARACTERISTICS**

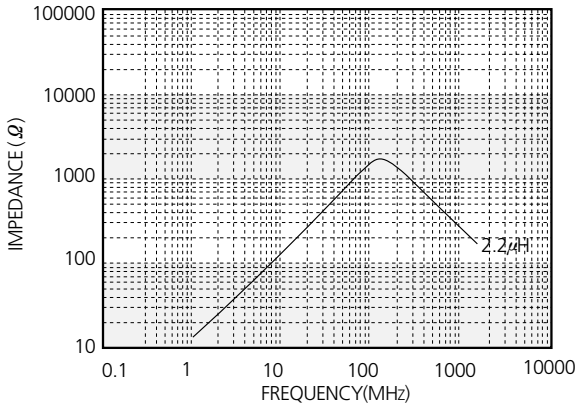

■ **Q CHARACTERISTICS**

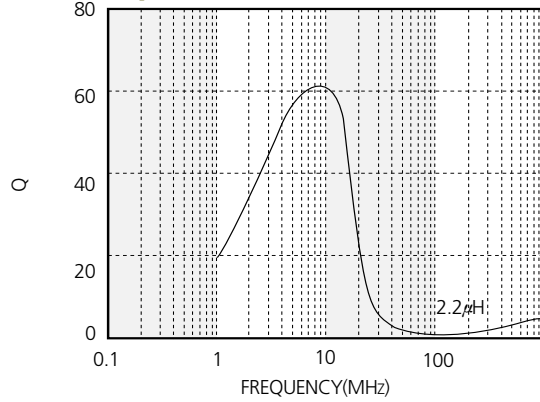

■ **DC BIAS CHARACTERISTICS**

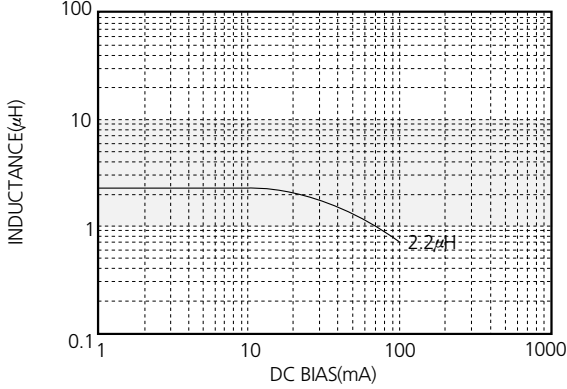

■ **TEMPERATURE CHARACTERISTICS**

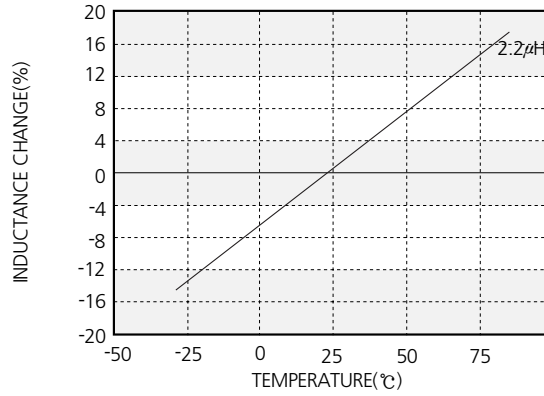

**CIL 1608(0603) Type**

■ **IMPEDANCE CHARACTERISTICS**

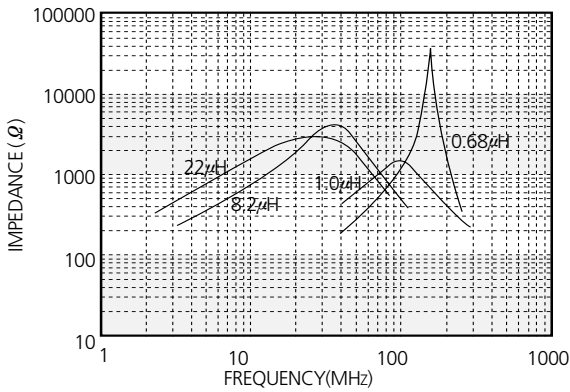

■ **Q CHARACTERISTICS**

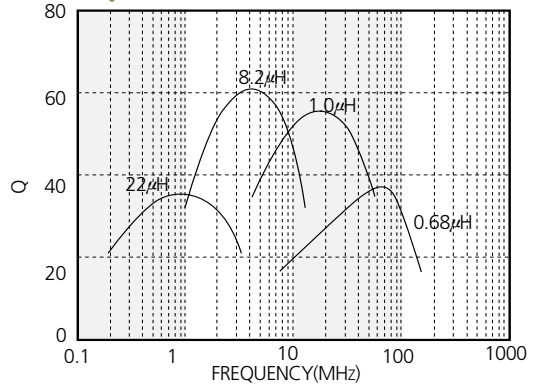

■ **DC BIAS CHARACTERISTICS**

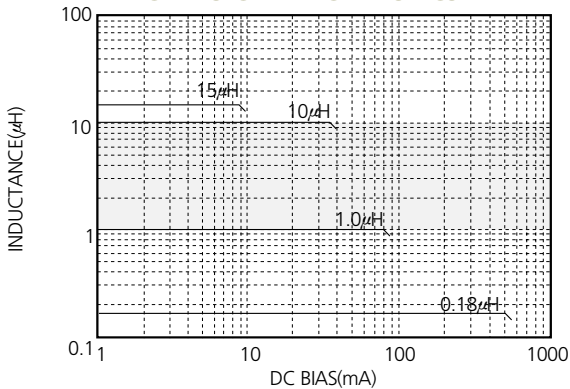

■ **TEMPERATURE CHARACTERISTICS**

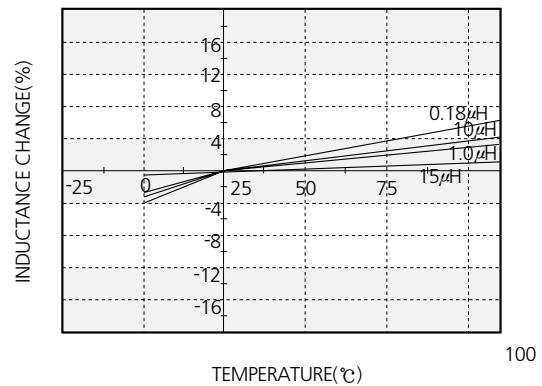

CIL 2012(0805) Type

■ IMPEDANCE CHARACTERISTICS

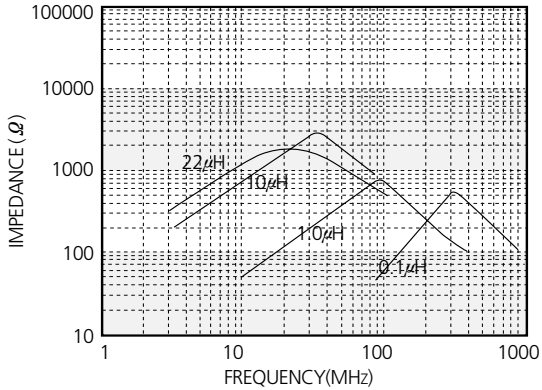

■ Q CHARACTERISTICS

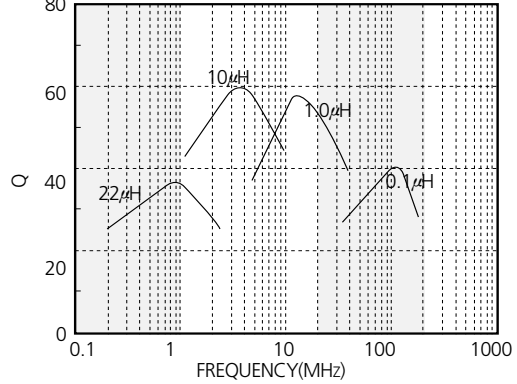

■ DC BIAS CHARACTERISTICS

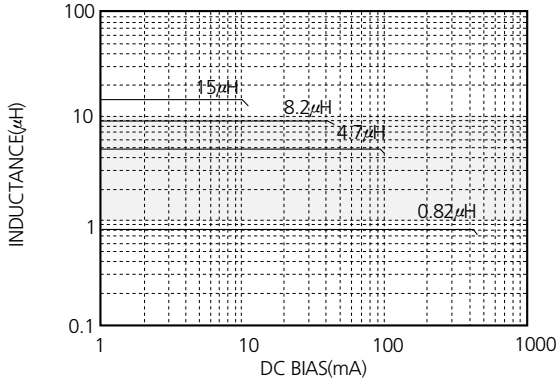

■ TEMPERATURE CHARACTERISTICS

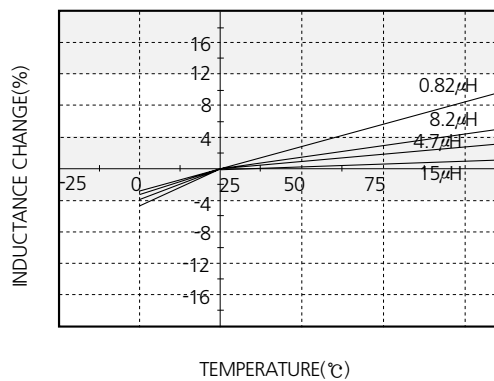

CIL 3216(1206) Type

■ IMPEDANCE CHARACTERISTICS

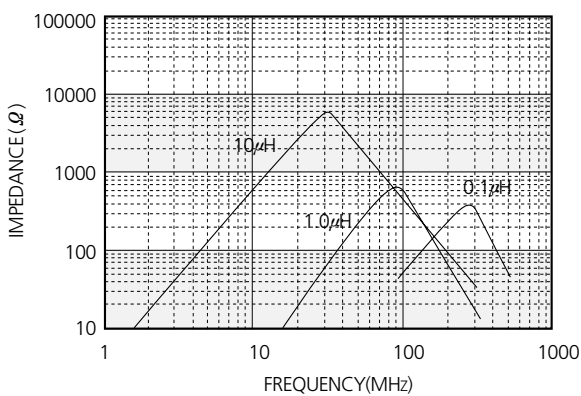

■ Q CHARACTERISTICS

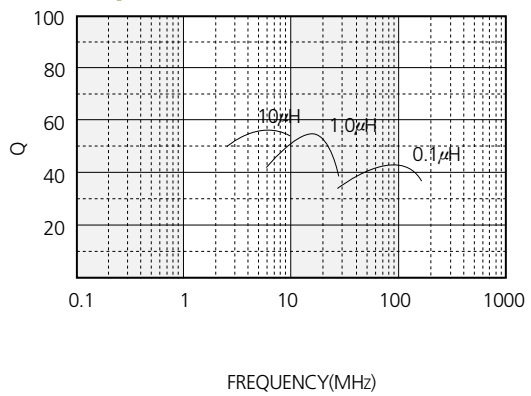

■ DC BIAS CHARACTERISTICS

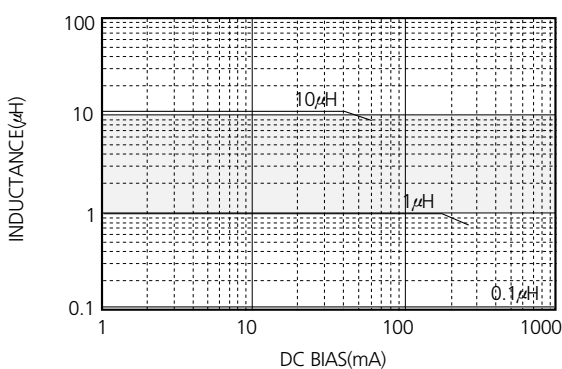

■ TEMPERATURE CHARACTERISTICS

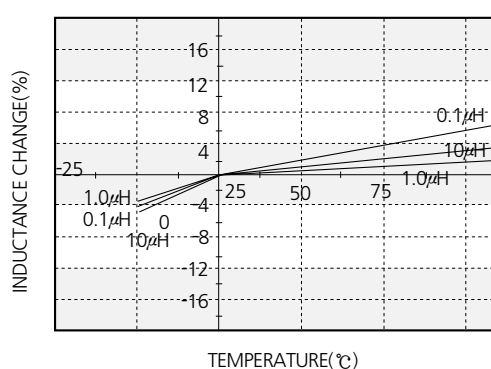

# Chip Inductor, CIH Series

## High Frequency Type



### Feature

- Lowest value of specific resistivity, good property of Q and high SRF.
- Possible to use at range above 100MHz
- Monolithic structure for high reliability.

### Application

- Mobile communication systems, noise suppression at high frequency and Impedance matching.

CIH Series has dielectric material and 100% Ag as an internal conductor Therefore, it has high Q and |Z| at high frequency. It is possible to use for high frequency over 100MHz.

Operating Temp	-55~+125°C
Storage Temp	-10~+40°C

### Dimensions

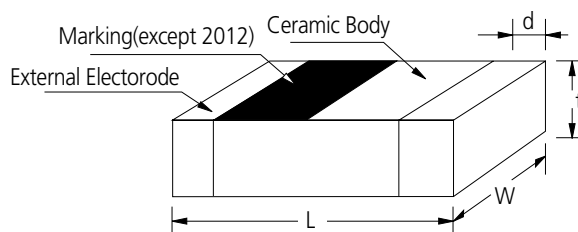

Unit : mm

SIZE CODE	L	W	t	d
03	0.6±0.03	0.3±0.03	0.3±0.03	0.15±0.05
05	1.0±0.05	0.5±0.05	0.5±0.05	0.25±0.1
10	1.6±0.15	0.8±0.15	0.8±0.15	0.3±0.2

### Part Numbering

**CI H 03 T 12N J N C**  
 (1) (2) (3) (4) (5) (6) (7) (8)

- (1) Chip Inductor
- (2) H: High frequency type
- (3) Dimension
- (4) Material code(T:Dielectric material)
- (5) Inductance(4N7:4.7nH, 10N:10nH, R10:100nH)
- (6) Tolerance(C: ±0.2nH, S: ±0.3nH, J: ±5%, K: ±10%)
- (7) Thickness option(N:Standard, A:Thinner than standard, B:Thicker than standard)
- (8) Packaging(C: paper tape, E:embossed tape)

CIH 0603(0201) Type

Part No.	Inductance (nH)	Q (Min.) 100 MHz	Q (typical) Frequency					SRF- Resonant Frequency (MHz) min	DC resistance ( $\Omega$ ) max	Rated current (mA) Max.
			500MHz	800MHz	1.8GHz	2.0GHz	2.4GHz			
CIH 03T 1N0 □	1.0±0.2nH, 0.3nH	4	17	20	28	30	33	13000	0.14	300
CIH 03T 1N2 □	1.2±0.2nH, 0.3nH	4	16	20	28	30	33	10000	0.14	250
CIH 03T 1N5 □	1.5±0.2nH, 0.3nH	4	15	20	27	29	32	10000	0.18	230
CIH 03T 1N8 □	1.8±0.2nH, 0.3nH	4	15	20	27	29	31	10000	0.19	200
CIH 03T 2N2 □	2.2±0.2nH, 0.3nH	4	15	20	26	28	30	8800	0.22	200
CIH 03T 2N7 □	2.7±0.2nH, 0.3nH	5	15	20	26	28	30	7700	0.25	200
CIH 03T 3N3 □	3.3±0.2nH, 0.3nH	5	15	20	26	28	30	6700	0.30	200
CIH 03T 3N9 □	3.9±0.2nH, 0.3nH	5	15	20	27	29	31	6000	0.30	200
CIH 03T 4N7 □	4.7±0.2nH, 0.3nH	5	15	19	26	28	30	5300	0.40	200
CIH 03T 5N6 □	5.6±0.2nH, 0.3nH	5	15	19	26	27	28	4600	0.40	200
CIH 03T 6N8 □	6.8±5%	5.5	14	18	23	24	25	4100	0.48	150
CIH 03T 8N2 □	8.2±5%	5	14	18	22	23	23	3400	0.55	150
CIH 03T 10N □	10.0±5%	5	14	17	22	22	21	3300	0.63	150
CIH 03T 12N □	12.0±5%	6	14	17	21	21	19	3000	0.70	150
CIH 03T 15N □	15.0±5%	6	13	16	19	18	14	2700	0.80	100
CIH 03T 18N □	18.0±5%	6	13	17	16	14	9	2100	0.90	100
CIH 03T 22N □	22.0±5%	5	13	15	14	11	5	1800	1.2	100
CIH 03T 27N □	27.0±5%	4	12	14	10	7	2	1800	1.8	50
CIH 03T 33N □	33.0±5%	4	12	14	8	5	1	1700	2.1	50
CIH 03T 39N □	39.0±5%	4	12	13	4	1	-	1500	2.4	50
CIH 03T 47N □	47.0±5%	4	11	12	2	-	-	1300	2.8	50
CIH 03T 56N □	56.0±5%	4	11	11	-	-	-	1100	3.0	50

□: Tolerance (C: ±0.2nH, S: ±0.3nH, J: ±5%)

\* Test equipment: Agilent E4991A+16196C

CIH  
Series

**CIH 1005(0402) Type**

Part No.	Inductance (nH) @100MHz	Q (Min) 100MHz	Q (typical.)					SRF (MHz) Min.	DC resistance ( $\Omega$ ) Max.	Rated current (mA) Max.
			500MHz	800MHz	1.8GHz	2.0GHz	2.4GHz			
CIH 05T 1N0 S	1.0±0.3nH	8	23	29	48	50	56	10000	0.12	300
CIH 05T 1N2 S	1.2±0.3nH	8	23	29	48	50	56	10000	0.12	300
CIH 05T 1N5 S	1.5±0.3nH	8	23	29	47	50	56	6000	0.13	300
CIH 05T 1N8 S	1.8±0.3nH	8	20	26	41	43	49	6000	0.14	300
CIH 05T 2N2 S	2.2±0.3nH	8	22	27	44	47	52	6000	0.16	300
CIH 05T 2N4 S	2.4±0.3nH	8	22	27	44	47	52	6000	0.16	300
CIH 05T 2N7 S	2.7±0.3nH	8	22	27	43	45	50	6000	0.17	300
CIH 05T 3N0 □	3.0±10%, 0.3nH	8	24	30	46	48	53	6000	0.19	300
CIH 05T 3N3 □	3.3±10%, 0.3nH	8	24	30	46	48	53	6000	0.19	300
CIH 05T 3N6 □	3.6±10%, 0.3nH	8	24	30	46	48	53	6000	0.19	300
CIH 05T 3N9 □	3.9±10%, 0.3nH	8	22	28	43	45	50	4000	0.22	300
CIH 05T 4N7 □	4.7±10%, 0.3nH	8	23	30	45	47	50	4000	0.24	300
CIH 05T 5N1 □	5.1±10%, 0.3nH	8	22	28	42	43	45	4000	0.27	300
CIH 05T 5N6 □	5.6±10%, 0.3nH	8	22	28	42	43	45	4000	0.27	300
CIH 05T 6N8 □	6.8±5%, 10%	8	22	28	40	41	41	3900	0.32	300
CIH 05T 7N5 □	7.5±5%, 10%	8	22	28	38	38	36	3600	0.37	300
CIH 05T 8N2 □	8.2±5%, 10%	8	22	28	38	38	36	3600	0.37	300
CIH 05T 10N □	10.0±5%, 10%	8	22	28	37	36	31	3200	0.42	300
CIH 05T 12N □	12.0±5%, 10%	8	22	28	33	31	23	2700	0.50	300
CIH 05T 15N □	15.0±5%, 10%	8	22	28	29	26	17	2300	0.55	300
CIH 05T 18N □	18.0±5%, 10%	8	23	28	26	22	11	2100	0.65	250
CIH 05T 22N □	22.0±5%, 10%	8	22	27	21	14	2	1900	0.80	250
CIH 05T 27N □	27.0±5%, 10%	8	20	23	10	3	-	1600	0.90	250
CIH 05T 33N □	33.0±5%, 10%	8	20	23	3	-	-	1300	1.00	250
CIH 05T 39N □	39.0±5%, 10%	8	20	21	-	-	-	1200	1.20	200
CIH 05T 47N □	47.0±5%, 10%	8	19	20	-	-	-	1000	1.30	200
CIH 05T 56N □	56.0±5%, 10%	8	19	18	-	-	-	750	1.40	180
CIH 05T 68N □	68.0±5%, 10%	8	17	15	-	-	-	750	1.40	180
CIH 05T 82N □	82.0±5%, 10%	8	16	11	-	-	-	600	1.60	150
CIH 05T R10 □	100.0±5%, 10%	8	15	9	-	-	-	600	1.60	130

□ : Tolerance (S: ±0.3nH, J: ±5%, K: ±10%)

\* Test equipment: Agilent 4291B+16192A

CIH 1608(0603) Type

Part No.	Inductance (nH) @100MHz	Q (typical)		SRF (MHz) Min.	DC resistance ( $\Omega$ ) Max.	Rated current (mA) Max.
		100MHz	800MHz			
CIH 10T 1N0 S	1.0 $\pm$ 0.3nH	8	20	10000	0.05	800
CIH 10T 1N2 S	1.2 $\pm$ 0.3nH	8	20	10000	0.05	800
CIH 10T 1N5 S	1.5 $\pm$ 0.3nH	8	20	6000	0.10	800
CIH 10T 1N8 S	1.8 $\pm$ 0.3nH	8	20	6000	0.10	800
CIH 10T 2N2 S	2.2 $\pm$ 0.3nH	8	20	6000	0.10	800
CIH 10T 2N7 S	2.7 $\pm$ 0.3nH	10	25	6000	0.10	800
CIH 10T 3N3□	3.3 $\pm$ 0.3nH, 10%	10	25	6000	0.12	800
CIH 10T 3N9□	3.9 $\pm$ 0.3nH, 10%	10	27	6000	0.14	800
CIH 10T 4N7□	4.7 $\pm$ 0.3nH, 10%	10	27	4000	0.16	800
CIH 10T 5N6□	5.6 $\pm$ 0.3nH, 10%	10	27	4000	0.18	800
CIH 10T 6N8□	6.8 $\pm$ 10%, 5%	10	27	4000	0.22	700
CIH 10T 8N2□	8.2 $\pm$ 10%, 5%	10	26	3500	0.24	700
CIH 10T 10N□	10.0 $\pm$ 10%, 5%	12	26	3400	0.26	600
CIH 10T 12N□	12.0 $\pm$ 10%, 5%	12	24	2600	0.28	600
CIH 10T 15N□	15.0 $\pm$ 10%, 5%	12	24	2300	0.32	500
CIH 10T 18N□	18.0 $\pm$ 10%, 5%	12	24	2000	0.35	500
CIH 10T 22N□	22.0 $\pm$ 10%, 5%	12	25	1600	0.40	500
CIH 10T 27N□	27.0 $\pm$ 10%, 5%	12	25	1400	0.45	500
CIH 10T 33N□	33.0 $\pm$ 10%, 5%	12	24	1200	0.55	500
CIH 10T 39N□	39.0 $\pm$ 10%, 5%	12	20	1100	0.60	400
CIH 10T 47N□	47.0 $\pm$ 10%, 5%	12	20	900	0.77	400
CIH 10T 56N□	56.0 $\pm$ 10%, 5%	12	20	900	0.75	400
CIH 10T 68N□	68.0 $\pm$ 10%, 5%	12	<sup>(1)</sup> 20	700	0.85	350
CIH 10T 82N□	82.0 $\pm$ 10%, 5%	12	<sup>(1)</sup> 20	600	0.95	350
CIH 10T R10□	100.0 $\pm$ 10%, 5%	12	<sup>(1)</sup> 20	600	1.00	350
CIH 10T R12□	120.0 $\pm$ 10%, 5%	<sup>(2)</sup> 8	-	500	1.20	300
CIH 10T R15□	150.0 $\pm$ 10%, 5%	<sup>(2)</sup> 8	-	500	1.20	250
CIH 10T R18□	180.0 $\pm$ 10%, 5%	<sup>(2)</sup> 8	-	400	1.30	250
CIH 10T R22□	220.0 $\pm$ 10%, 5%	<sup>(2)</sup> 8	-	400	1.50	200
CIH 10T R27□	270.0 $\pm$ 10%, 5%	<sup>(2)</sup> 8	-	400	1.50	200

□: Tolerance (S:  $\pm$ 0.3nH, J:  $\pm$ 5%, K:  $\pm$ 10%)

\* Test equipment: Agilent 4291B+16192A

<sup>(1)</sup> 500MHz, <sup>(2)</sup> 50MHz,

CIH  
Series

# Power Inductor; CIG Series

## DC-DC converter Type

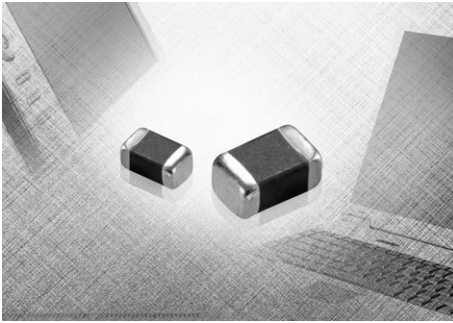

### General Features

- Low profile (1.0mm max height)
- Magnetically shielded and Low DC resistance
- Lead free termination and internal electrode
- Monolithic structure for high reliability

### Application

- Mobile phones, DSC, DVC, PDA etc. for DC-DC Converter

### Dimensions

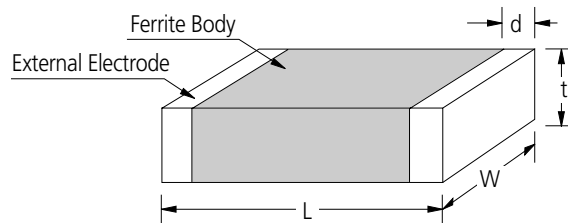

SIZE CODE	Dimension (mm)			
	L	W	t	d
CIG10F Series	1.6±0.15	0.8±0.15	0.5 max	0.1~0.5
CIG10W Series	1.6±0.15	0.8±0.15	0.8 max	0.1~0.5
CIG21F Series	2.0±0.1	1.25±0.1	0.5 max	0.2~0.7
CIG21W Series	2.0±0.2	1.25±0.2	1.0 max	0.2~0.7
CIG21L Series	2.0±0.1	1.25±0.1	1.0 max	0.2~0.7
CIG21C Series	2.0±0.1	1.25±0.1	1.0 max	0.2~0.7
CIG22L Series	2.5±0.2	2.0±0.2	1.0 max	0.3~0.8
CIG22H Series	2.5±0.2	2.0±0.2	1.2 max	0.3~0.8
CIG22B Series	2.5±0.2	2.0±0.2	1.0 max	0.3~0.8

### Part Numbering

**CI G 22 L 4R7 M N E**  
 (1) (2) (3) (4) (5) (6) (7) (8)

- (1) Chip inductor
- (2) Power inductor
- (3) Dimensions (10:1608, 21:2012, 22:2520)
- (4) Product Series (W: Normal Type, L: Low Rdc Type, F: Low profile Type, H: High Current Type, B: High Current & Low Profile Type)
- (5) Inductance (R47: 0.47uH, 2R2: 2.2uH, 4R7: 4.7uH)
- (6) Tolerance (M: ±20%)
- (7) Thickness Option (N: Standard, A: Thinner than standard, B: Thicker than standard)
- (8) Package Style (C: Paper tape / 7" reel, E: Embossed tape / 7" reel)

**CIG 1608(0603) Type - Low Profile**

Part No.	Inductance ( $\mu$ H) @1MHz	DC Resistance ( $\Omega$ )	Rated Current. I <sub>dc</sub> (A) $\Delta T = 40^\circ C$
CIG10FR47MNC	0.47 $\pm$ 20 %	0.20 $\pm$ 30 %	0.80
CIG10F1R0MNC	1.0 $\pm$ 20 %	0.30 $\pm$ 30 %	0.70
CIG10F1R5MNC	1.5 $\pm$ 20 %	0.35 $\pm$ 30 %	0.60
CIG10F2R2MNC	2.2 $\pm$ 20 %	0.45 $\pm$ 30 %	0.50

**INDUCTANCE**

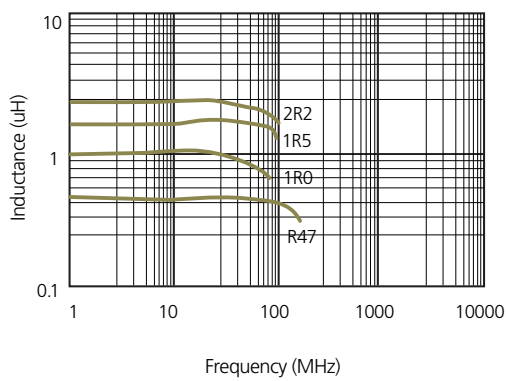

**DC BIAS CHARACTERISTIC**

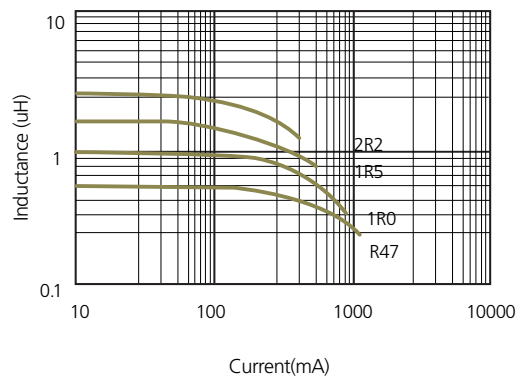

**CIG 1608(0603) Type**

Part No.	Inductance ( $\mu$ H) @1MHz	DC Resistance ( $\Omega$ )	Rated Current. I <sub>dc</sub> (A) $\Delta T = 40^\circ C$
CIG10WR47MNC	0.47 $\pm$ 20 %	0.15 $\pm$ 20 %	1.10
CIG10W1R0MNC	1.0 $\pm$ 20 %	0.20 $\pm$ 20 %	0.95
CIG10W1R5MNC	1.5 $\pm$ 20 %	0.25 $\pm$ 20 %	0.80
CIG10W2R2MNC	2.2 $\pm$ 20 %	0.30 $\pm$ 20 %	0.75
CIG10W3R3MNC	3.3 $\pm$ 20 %	0.40 $\pm$ 20 %	0.70
CIG10W4R7MNC	4.7 $\pm$ 20 %	0.50 $\pm$ 20 %	0.62

**INDUCTANCE**

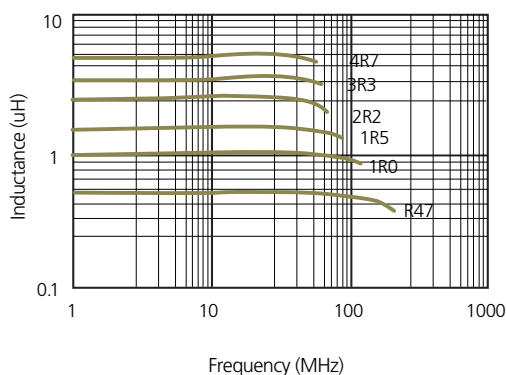

**DC BIAS CHARACTERISTIC**

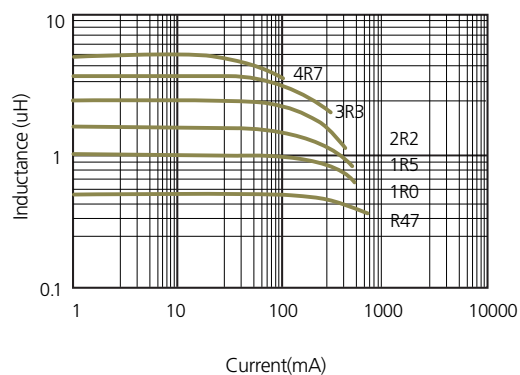





### CIG 2012(0805) Type - Low Profile

Part No.	Inductance ( $\mu\text{H}$ ) @1MHz	DC Resistance ( $\Omega$ )	Rated Current. Idc (A) $\Delta T = 40^\circ\text{C}$
CIG21FR47MNC	$0.47 \pm 20\%$	$0.12 \pm 25\%$	1.10
CIG21F1R0MNC	$1.0 \pm 20\%$	$0.19 \pm 25\%$	0.80
CIG21F1R5MNC	$1.5 \pm 20\%$	$0.25 \pm 25\%$	0.70
CIG21F2R2MNC	$2.2 \pm 20\%$	$0.34 \pm 25\%$	0.60

INDUCTANCE

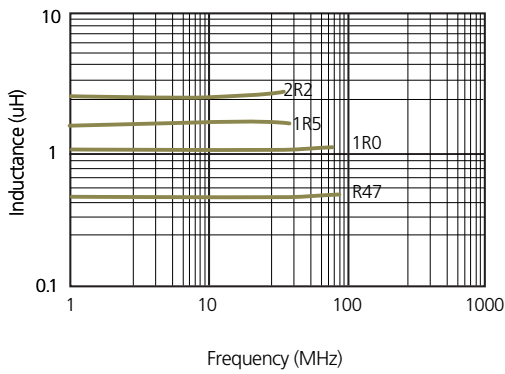

DC BIAS CHARACTERISTIC

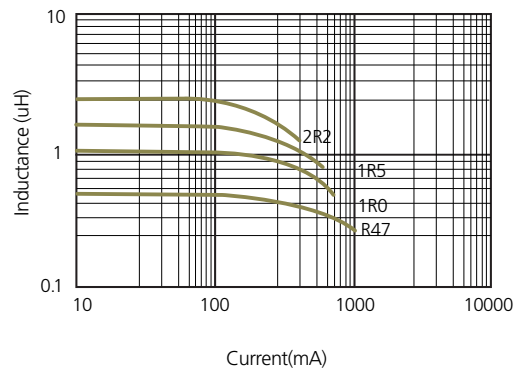

### CIG 2012(0805) Type

Part No.	Inductance ( $\mu\text{H}$ ) @1MHz	DC Resistance ( $\Omega$ )	Rated Current. Idc (A) $\Delta T = 40^\circ\text{C}$
CIG21W1R0MNE	$1.0 \pm 20\%$	$0.13 \pm 20\%$	1.05
CIG21W1R5MNE	$1.5 \pm 20\%$	$0.15 \pm 20\%$	0.96
CIG21W2R2MNE	$2.2 \pm 20\%$	$0.20 \pm 20\%$	0.81
CIG21W3R3MNE	$3.3 \pm 20\%$	$0.25 \pm 20\%$	0.73
CIG21W4R7MNE	$4.7 \pm 20\%$	$0.30 \pm 20\%$	0.65

INDUCTANCE

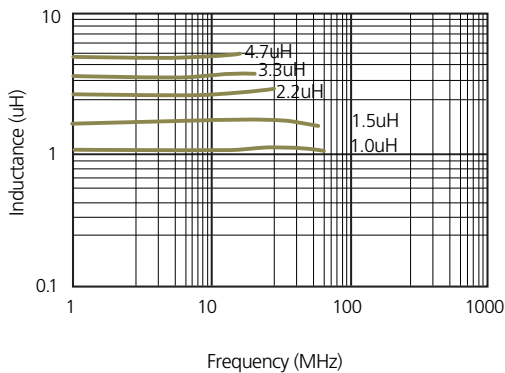

DC BIAS CHARACTERISTIC

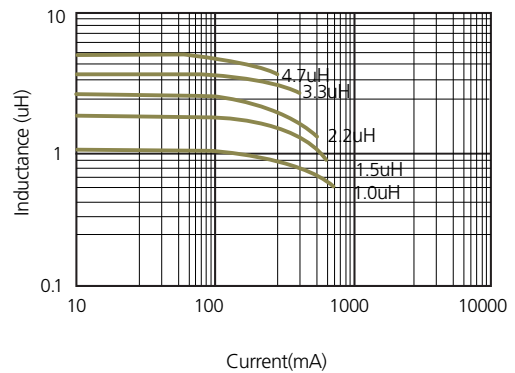

**CIG 2012(0805) Type - Low RDC**

Part No.	Inductance ( $\mu\text{H}$ ) @1MHz	DC Resistance ( $\Omega$ )	Rated Current. Idc (A) $\Delta T = 40^\circ\text{C}$
CIG21LR47MNE	$0.47 \pm 20\%$	$0.08 \pm 20\%$	1.30
CIG21L1R0MNE	$1.0 \pm 20\%$	$0.11 \pm 20\%$	1.15
CIG21L1R5MNE	$1.5 \pm 20\%$	$0.14 \pm 20\%$	1.05
CIG21L2R2MNE	$2.2 \pm 20\%$	$0.16 \pm 20\%$	0.95
CIG21L3R3MNE	$3.3 \pm 20\%$	$0.22 \pm 20\%$	0.80
CIG21L4R7MNE	$4.7 \pm 20\%$	$0.26 \pm 20\%$	0.75

**INDUCTANCE**

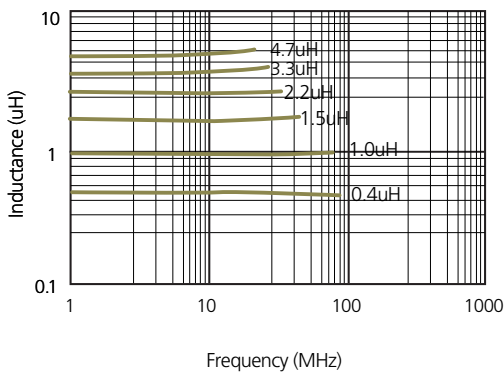

**DC BIAS CHARACTERISTIC**

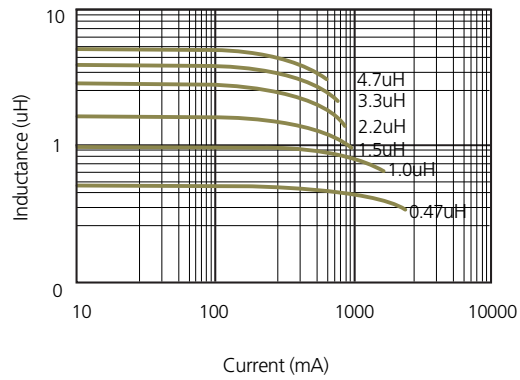

**CIG 2012(0805) Type - Choke**

Part No.	Inductance ( $\mu\text{H}$ ) @1MHz	DC Resistance ( $\Omega$ )	Rated Current. Idc (A) $\Delta T = 40^\circ\text{C}$
CIG21C2R2MNE	$2.2 \pm 20\%$	$0.25 \pm 20\%$	0.77
CIG21C4R7MNE	$4.7 \pm 20\%$	$0.43 \pm 20\%$	0.58

**INDUCTANCE**

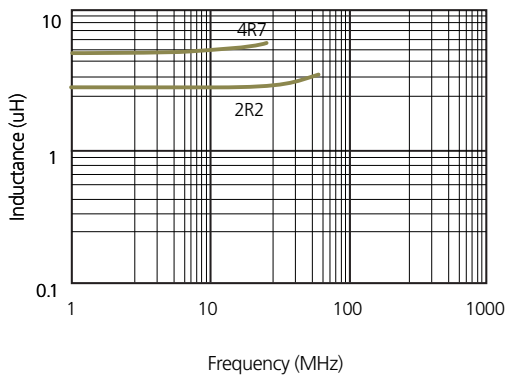

**DC BIAS CHARACTERISTIC**

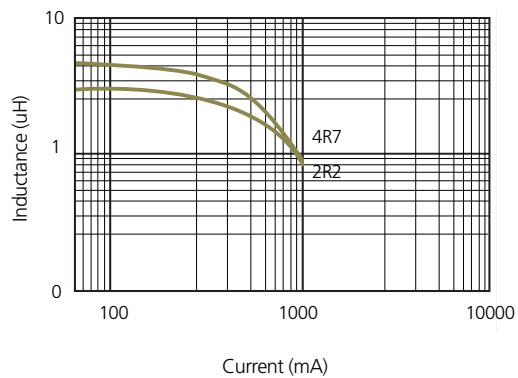



### CIG 2520(1008) Type - High Current

Part No.	Inductance ( $\mu\text{H}$ ) @1MHz	DC Resistance ( $\Omega$ )	Rated Current. Idc (A) Typ. $\Delta T = 40^\circ\text{C}$
CIG22H1R0MNE	$1.0 \pm 20\%$	$0.083 \pm 20\%$	2.0
CIG22H2R2MNE	$2.2 \pm 20\%$	$0.116 \pm 20\%$	1.6
CIG22H3R3MNE	$3.3 \pm 20\%$	$0.133 \pm 20\%$	1.5
CIG22H4R7MNE	$4.7 \pm 20\%$	$0.233 \pm 20\%$	1.0

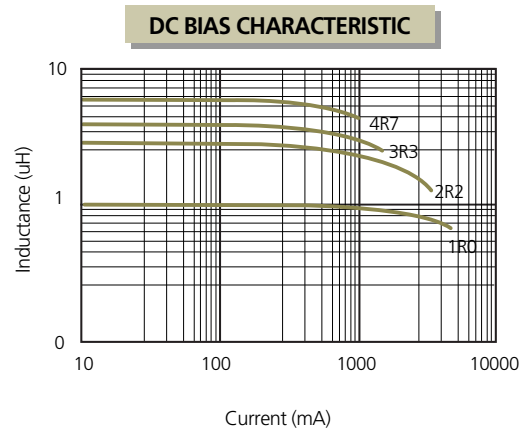
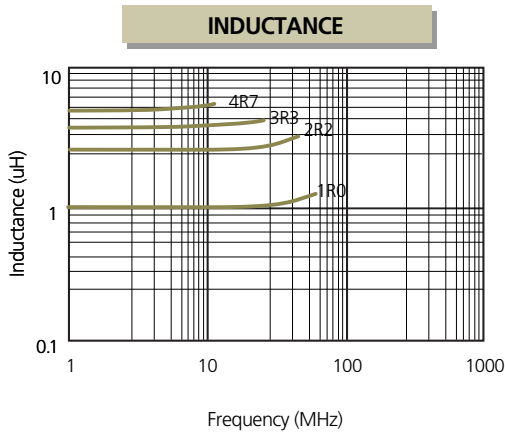

### CIG 2520(1008) Type - High Current and Low Profile

Part No.	Inductance ( $\mu\text{H}$ ) @1MHz	DC Resistance ( $\Omega$ )	Rated Current. Idc (A) $\Delta T = 40^\circ\text{C}$
CIG22B1R0MNE	$1.0 \pm 20\%$	$0.12 \pm 20\%$	1.2
CIG22B2R2MNE	$2.2 \pm 20\%$	$0.18 \pm 20\%$	1.1
CIG22B3R3MNE	$3.3 \pm 20\%$	$0.21 \pm 20\%$	1.05
CIG22B4R7MNE	$4.7 \pm 20\%$	$0.25 \pm 20\%$	1.0

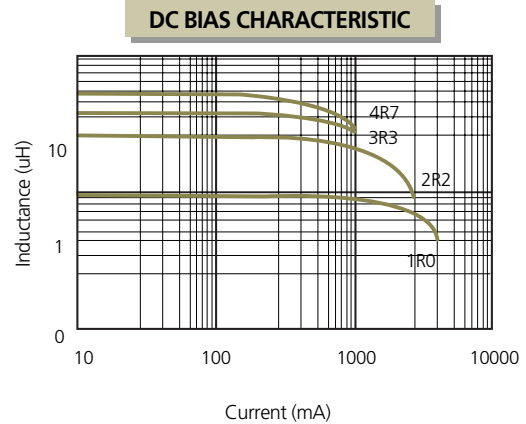
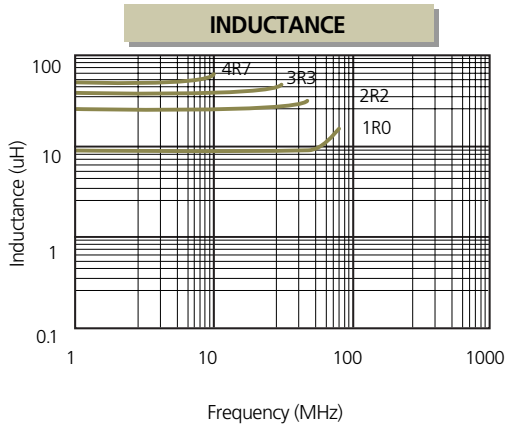

**CIG 2520(1008) Type - Low RDC**

Part No.	Inductance ( $\mu$ H) @1MHz	DC Resistance ( $\Omega$ )	Rated Current. I <sub>dc</sub> (A) $\Delta T = 40^\circ\text{C}$
CIG22L1R0MNE	1.0 $\pm$ 20 %	0.06 $\pm$ 25 %	1.6
CIG22L1R2MNE	1.2 $\pm$ 20 %	0.065 $\pm$ 25 %	1.5
CIG22L1R5MNE	1.5 $\pm$ 20 %	0.07 $\pm$ 25 %	1.5
CIG22L2R2MNE	2.2 $\pm$ 20 %	0.08 $\pm$ 25 %	1.3
CIG22L3R3MNE	3.3 $\pm$ 20 %	0.10 $\pm$ 25 %	1.2
CIG22L4R7MNE	4.7 $\pm$ 20 %	0.11 $\pm$ 25 %	1.1
CIG22L6R8MNE	6.8 $\pm$ 20 %	0.20 $\pm$ 30 %	0.8
CIG22L100MNE	10.0 $\pm$ 20 %	0.32 $\pm$ 30 %	0.6

\* Test equipment: Agilent 4291B+16193A

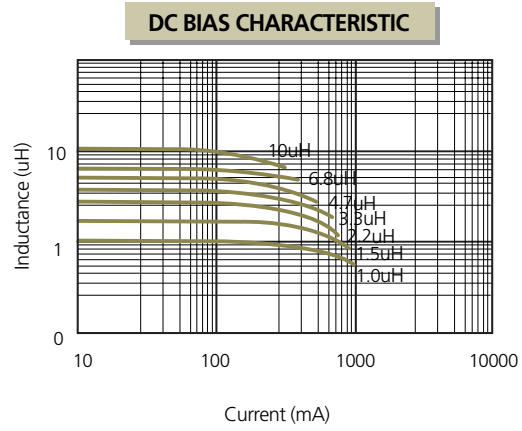
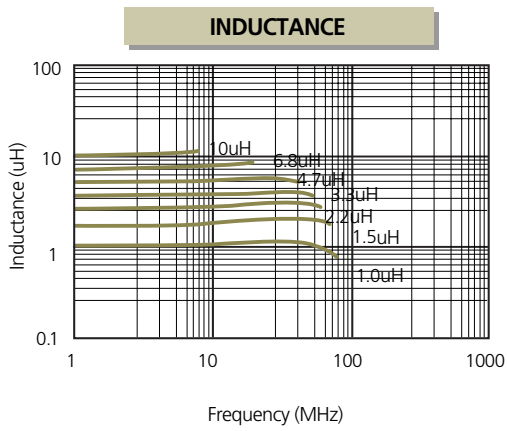

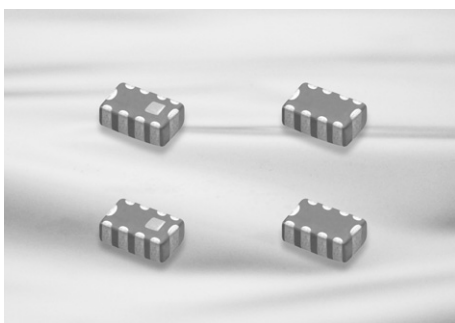

### Feature

- EMI LC Filter's Property
  - Steep Cut off frequency Characteristics
  - Good Attenuation in GSM, CDMA, PCS Frequency Range (570 MHz ~ 1900 MHz)
  - High Attenuation Characteristics (-20 dB) on broad band (450 MHz ~ 3000 MHz)
  - No deterioration of signal level in Low Frequency range
  - No Voltage Drop phenomena (Low DC Resistance)
- ESD LC Filter's Property
  - High  $\alpha$  Value
  - Assurance of 8kV ESD Protection (contact discharge)

### Application

- Suitable for high speed data lines, I/O
- Noise suppression of Digital Equipment
- Applicable to LCD line and Camera circuit of HHP

EMI LC filter reduces EMI emissions in LCD, camera lines and protect against ESD.  
ESD LC Filter also applies to LCD and camera data lines and provides high-level of ESD protection as well as EMI suppression.

### Dimensions

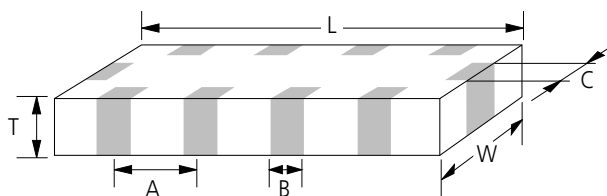

Unit : mm

SIZE CODE	L	W	T	A	B	C
10	1.60±0.1	0.8±0.1	0.55±0.1	0.40±0.1	0.20±0.1	0.20±0.1
21	2.00±0.2	1.25±0.2	0.75±0.2 0.55±0.1	0.50±0.1	0.25±0.1	0.40 + 0.2/-0.1

### Part Numbering

**EMIL 21 C 180 S A N E**  
(1) (2) (3) (4) (5) (6) (7) (8)

- (1) Chip EMI Filter LC Array
- (2) Dimension
- (3) Capacitance Temperature Characteristics [C : ±30(ppm/°C) at -40°C ~ +85°C]
- (4) Nominal Capacitance [180 : 18(pF)]
- (5) Capacitance Tolerance [S : -20% ~ +50%, M : ±20%]
- (6) Rated Voltage [B : 50(V), A : 25(V), O : 16(V), P : 10(V)]
- (7) Thickness Option  
(N:Standard, A:Thinner than standard, B: Thicker than standard)
- (8) Packaging  
(C:Paper Type, E: Embossed Type)

## Type of Filters & Equivalent Circuits

Type	EMI LC Array	
	$\pi$ Type Filter	L Type Filter
Equivalent Circuit		
Line up	EMIL21C070SANE EMIL21C150SANE EMIL21C180SANE EMIL21C270SAAE	EMIL21C220MANE EMIL10C220MPAC

## EMI LC Array Type

Part Number	Nominal Capacitance (pF) (at 1MHz)	Cut-off Frequency (MHz)	Rated Voltage (V)DC	Rated Current (mA)	Insulation Resistance (M $\Omega$ )	Typical Attenuation Range (MHz)
EMIL21C070SANE	7	450	25	100	Min. 1000	750~900(25dB)
EMIL21C150SANE	15	350	25	100	Min. 1000	750~1200(30dB)
EMIL21C180SANE	18	350	25	100	Min. 1000	760~1360(35dB)
EMIL21C220MANE	22	300	25	100	Min. 1000	700~1500(20dB)
EMIL21C270SAAE	27	400	25	100	Min. 1000	700~1500(30dB)
EMIL10C220MPAC	22	360	10	35	Min. 1000	820~1580(30dB)

EMI LC Array Type

EMIL21C070SANE

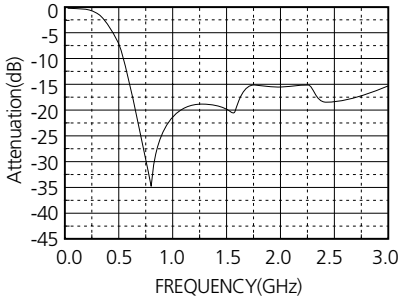

EMIL21C150SANE

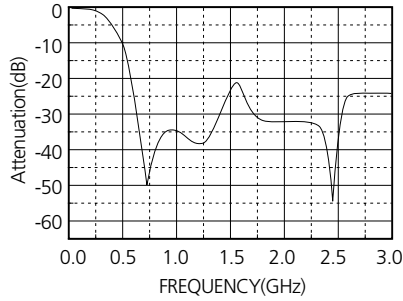

EMIL21C180SANE

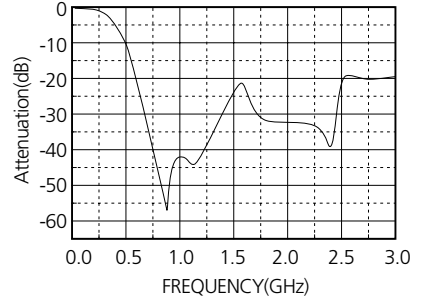

EMIL21C220MANE

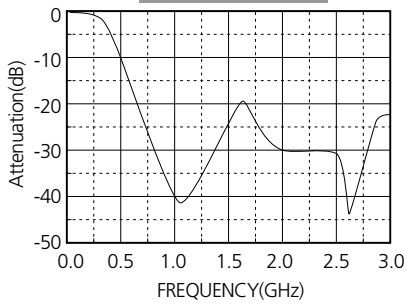

EMIL21C270SAAE

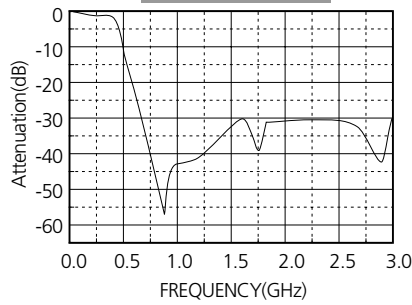

EMIL10C220MPAC

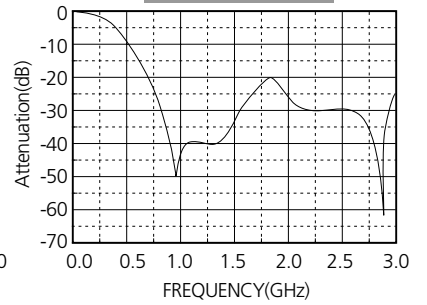

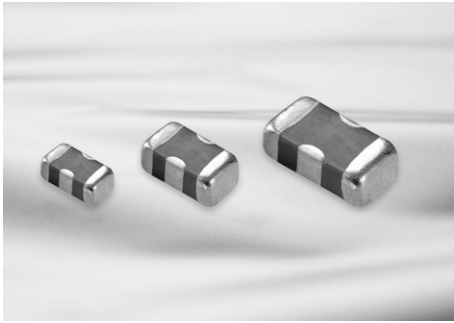

### Feature

- Lower ESL Characteristics
- High Performance at High Frequency Range
- Small size enables high density mounting
- Effective noise suppression filter

### Application

- High frequency EMI prevention applicable to digital equipment such as TV, VCR, LCD monitors and PDP TVs.
- Computer equipment such as personal computers and peripherals.

More excellent by-pass filter than MLCC.  
EMIC Series is capacitor type of three terminals and low residual inductance value.

### Dimensions

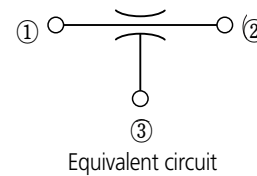
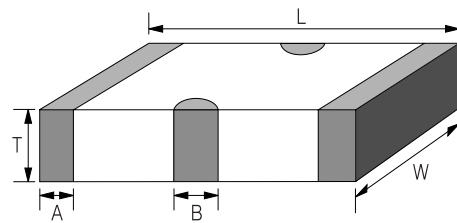

Unit : mm

SIZE CODE	L	W	T	A	B
10	1.6±0.15	0.8±0.1	0.6±0.1	0.25±0.15	0.4±0.1
21	2.0±0.2	1.25±0.2	0.8±0.2	0.3±0.2	0.6±0.2
31	3.2±0.2	1.6±0.2	1.1max	0.4±0.3	1.0±0.3

### Part Numbering

**EMIC 10 B 473 S A N C**  
(1) (2) (3) (4) (5) (6) (7) (8)

- (1) Chip EMI Filter 3-Terminal Capacitor For Signal line
- (2) Dimensions
- (3) Capacitance temperature characteristics  
C : 0±30ppm/°C  
A : ±15%(-55~85°C)  
B : ±15% (-55~125°C)  
F : -82~+22% (-30~+85°C)
- (4) Nominal capacitance (101: 100pF, 102: 1000pF, 104: 100000pF)
- (5) Capacitance tolerance (M: ±20%, S: +50%,-20%)
- (6) Rated voltage (P: 10V, O: 16V, A: 25V, B: 50V)
- (7) Thickness option (N: Standard, A: Thinner than standard, B: Thicker than standard)
- (8) Packaging (C: Paper 7" Reel, D: Paper 13" Reel)

3-Terminal Capacitor



**EMIC 1608(0603) Type**

Part No.	Capacitance (pF)	Tolerance	Rated Voltage (V) Max.	Insulation Resistance (M $\Omega$ )	DC Resistance ( $\Omega$ ) Max.	Rated Current (mA) Max
EMIC10B104MONC	100000	+20~-20%	16	1000 min	0.1	2000

**EMIC 2012(0805) Type**

Part No.	Capacitance (pF)	Tolerance	Rated Voltage (V) Max.	Insulation Resistance (M $\Omega$ )	DC Resistance ( $\Omega$ ) Max.	Rated Current (mA) Max
EMIC21B471SBNC	470	+50~-20%	50	10000 min	0.3	300
EMIC21B223SBNC	22000	+50~-20%	50	10000 min	0.08	1000
EMIC21F104SANC	100000	+50~-20%	25	1000 min	0.1	1000

**EMIC 3216(1206) Type**

Part No.	Capacitance (pF)	Tolerance	Rated Voltage (V) Max.	Insulation Resistance (M $\Omega$ )	DC Resistance ( $\Omega$ ) Max.	Rated Current (mA) Max
EMIC31B222MANC	2200	+20~-20%	25	1000 min	0.3	300
EMIC31B104SANC	100000	+50~-20%	25	1000 min	0.1	1000

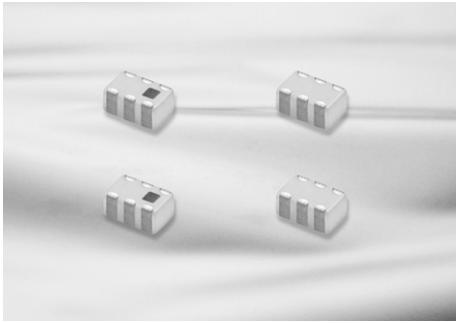

**Feature**

- Small and thin size
- Low Insertion Loss
- Lead free

**Application**

- Applying to mobile phones and wireless LAN Combo.
- AMPS/GPS, AMPS/PCS, CDMAWCDMA, CDMA/S-DMB, PCS/S-DMB, T-DMB/CDMA,
- T-DMB/K-PCS, CDMAW-LAN, CDMA/K-PCS, iDEN/GPS

Diplexer is used for separating specific frequency in mobile phones and wireless LAN 11a/b/g. Two kinds of pin assignment demanded on customers are lined up so that designing circuit regardless output direction is available.

**Dimensions**

■ F Type

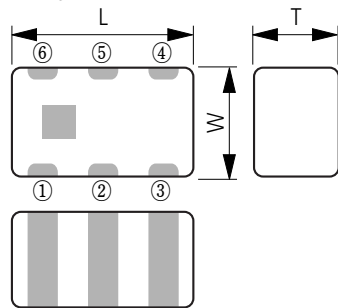

■ H Type

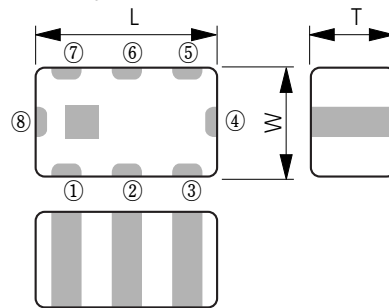

Dimension(mm)		Terminal	
L	2.00±0.15	Common	②
W	1.25±0.15	Low Band	⑥
		High Band	④
T	0.95±0.15	GND	① ③ ⑤

Dimension(mm)		Terminal	
L	2.00±0.15	Common	②
W	1.25±0.15	Low Band	⑧
		High Band	④
T	0.95±0.15	GND	①③⑤⑥⑦

\* Pin assignment can be changeable

**Part Numbering**

- DX 21 T F 3L 01**  
 (1) (2) (3) (4) (5) (6)
- (1) Diplexer
  - (2) Dimension
  - (3) Material code
  - (4) Terminal number (F: 6, H: 8)
  - (5) Low band: Band 3  
High band: L Band
  - (6) Serial number, pin assignment

## HHP Diplexer

Part No.	Application	Thickness (mm)	Center Frequency	Insertion Loss (dB) Max.	Attenuation(dB) Min.
DX21TFAG01	AMPS / GPS	0.95	859MHz/ 1575MHz	0.5 at 859MHz	20 at 1920MHz
				0.55 at 1920MHz	20 at 859MHz
DX21TFAG02	AMPS / GPS	0.95	859MHz/ 1575MHz	0.5 at 942.5MHz	20 at 1960MHz
				0.55 at 1960MHz	20 at 942.5MHz
DX21TFAP02	AMPS / PCS	0.95	859MHz/ 1920MHz	0.5 at 881.5MHz	20 at 1842.5MHz
				0.55 at 1842.5MHz	20 at 881.5MHz
DX21TFAP03	AMPS / PCS	0.95	859MHz/ 1920MHz	0.5 at 859MHz	15 at 2045MHz
				0.6 at 2045MHz	20 at 859MHz
DX21DFIG01	iDEN / GPS	1.05	873.5MHz/ 1575.42MHz	0.65 at 873.5MHz	16 at 1575.42MHz
					16 at 1631MHz
					13 at 1798MHz
				0.70 at 1575.42MHz	17 at 873.5MHz
DX21TFCD01	CDMA / S-DMB	0.95	859MHz/ 2630MHz	0.5 at 859MHz	20 at 2630MHz
				0.6 at 2630MHz	20 at 859MHz
DX21TFCD02	CDMA / S-DMB	0.95	859MHz/ 2630MHz	0.5 at 859MHz	17 at 2630MHz
				0.6 at 2630MHz	20 at 859MHz
DX21TFCL01	CDMA / W-LAN	0.95	859MHz/ 2450MHz	0.5 at 859MHz	20 at 2450MHz
				0.6 at 2450MHz	20 at 859MHz
DX21TFKL01	K-PCS / W-LAN	0.95	1810MHz/ 2450MHz	0.8 at 1810MHz	15 at 2450MHz
				1.0 at 2450MHz	15 at 1810MHz
DX21TFCM01	Cellular / WiMAX	1.00	1368MHz/ 2592.5MHz	1.0 at 1368MHz	15 at 2592.5MHz
				1.2 at 2592.5MHz	20 at 1368MHz

## Electrical Characteristics

**DX21TFAG01**

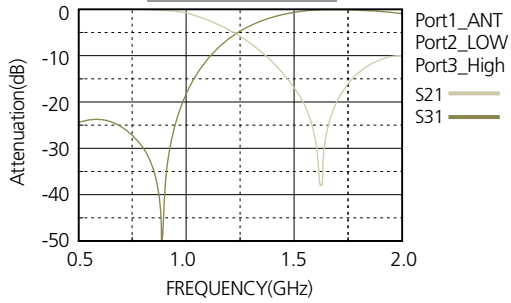

**DX21TFAG02**

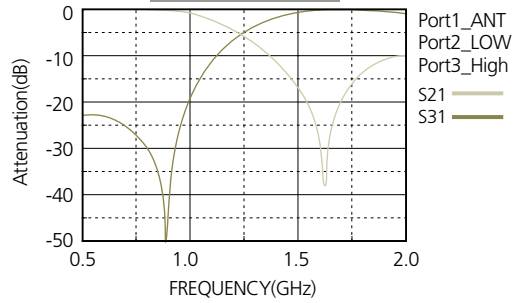

**DX21TFAP02**

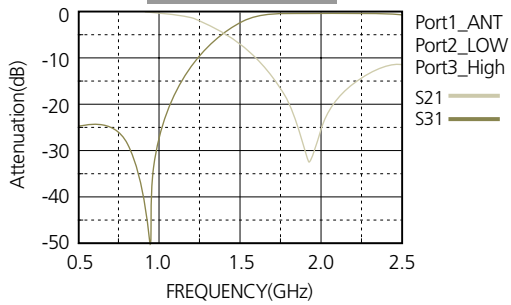

**DX21TFAP03**

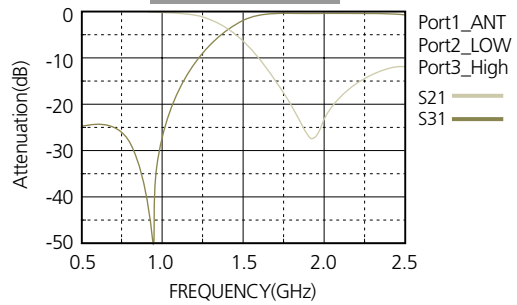

**DX21DFIG01**

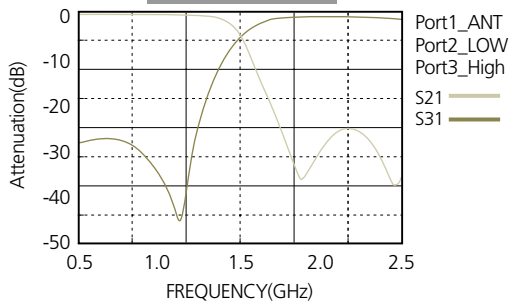

**DX21TFCD01**

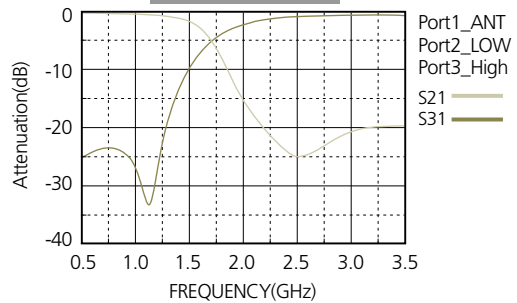

**DX21TFCD02**

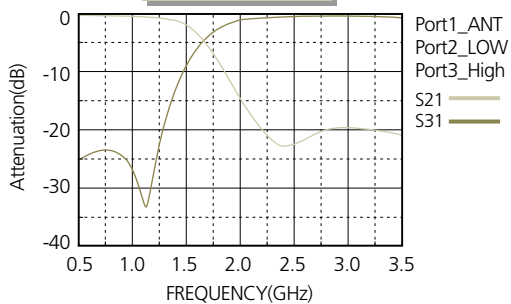

**DX21TFCL01**

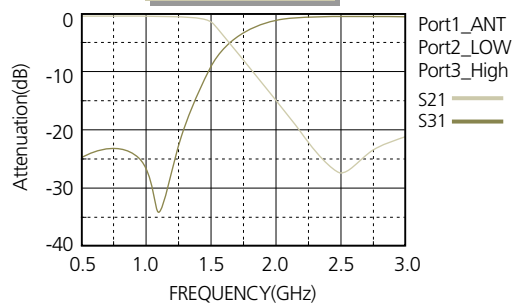

**DX21TFKL01**

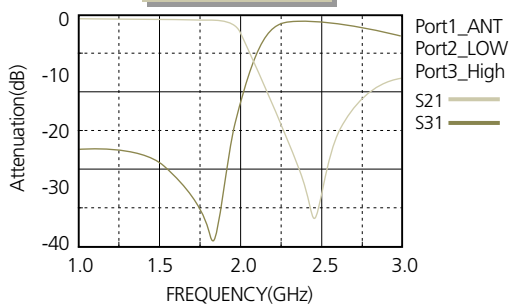

**DX21TFCM01**

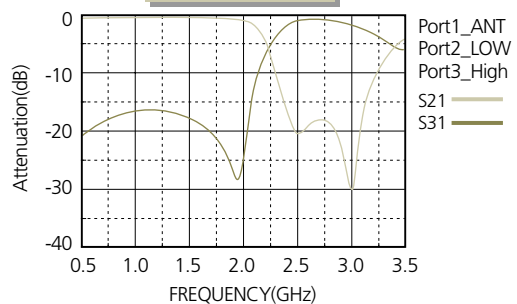

# LC Filter

Band pass/Low pass filter

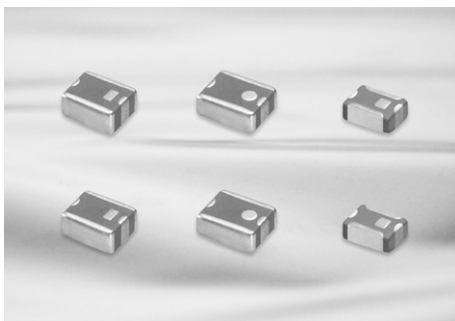

## Feature

- High Attenuation, Low Insertion Loss
- Small and Thin size
- Lead free

## Application

- Bluetooth Module
- W-LAN Module
- HHP-WiBro, WiMAX, DMB

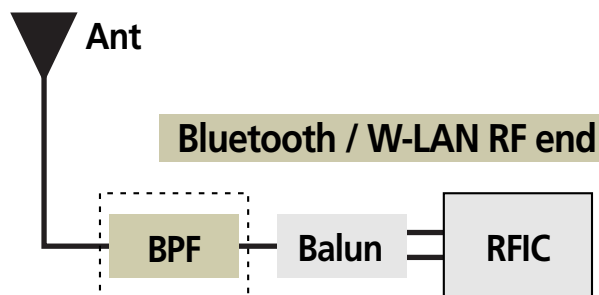

Chip LC filter made by our own RF design and LTCC fabrication technology has excellent products with low loss and good attenuation characteristics

## Part Numbering

<b>LC</b>	<b>B</b>	<b>10</b>	<b>C</b>	<b>2450</b>	<b>K1</b>
(1)	(2)	(3)	(4)	(5)	(6)

- (1) Chip LC Filter
- (2) B: Band Pass Filter, L : Low Pass Filter
- (3) Dimension (10 : 1.6x0.8mm, 21 : 2.0x1.25mm)
- (4) Material code (C, M, T)
- (5) Center frequency [MHz]
- (6) Serial Number

### Band Pass Filter

Application	Part No.	L × W × T (mm)	Pass Band (GHz)	IL (dB) Max.	VSWR (dB) Min.	Attenuation (dB) Min. (at MHz)			
11b/g BT	LCB22M2450B1	2.5×2.0×1.0	2.4 ~2.5	1.2	2.0	50 (1200)	30 (2f0)		
	LCB22B2450L1	2.5×2.0×1.0	2.4 ~2.5	2.2	2.0	40 (2100)	30 (2f0)		
	LCB22B2450S1	2.5×2.0×1.0	2.4 ~2.5	2.5	2.0	20 (1700~1900)	20 (2700)	30 (2f0)	15 (3f0)
	LCB21B2450F2	2.0×1.25×0.75	2.4 ~2.5	2.6	2.0	40 (880~960)	30 (1710~1990)	30 (2f0)	35 (2f0)
	LCB21B2450Q1	2.0×1.25×0.95	2.4 ~2.5	1.8	2.0	30 (1300)	10 (2000)	20 (3600)	30 (2f0)
	LCB21B2450Q3	2.0×1.25×0.75	2.4 ~2.5	1.8	2.0	30 (1300)	10 (2000)	15 (3600)	20 (3f0)
	LCB10C2450K1	1.6×0.8×0.6	2.4 ~2.5	2.5	2.0	35 (880~960)	12 (1710~1990)	16 (2f0)	20 (3f0)
	LCB10B2450K3	1.6×0.8×0.6	2.4 ~2.5	2.2	2.0	25 (880~960)	16 (2f0)	20 (3f0)	
T-DMB	LCB22G0205A3	2.5×2.0×1.2	0.174 ~0.237	1.5	2.0	10 (100)	40 (1750~1870)		
	LCB22G0205B3	2.5×2.0×1.2	0.174 ~0.237	1.5	2.0	10 (100)	40 (824~894)		

### Low Pass Filter

Application	Part No.	L × W × T (mm)	Pass Band (GHz)	IL (dB) Max.	VSWR (dB) Min.	Attenuation (dB) Min. (at MHz)			
WiBro WiMAX	LCL10T2500A1	1.6×0.8×0.6	2.3 ~2.7	0.55	1.7	(2f0)	25 (3f0)		

**Dimensions & Frequency Characteristics Band Pass Filter**

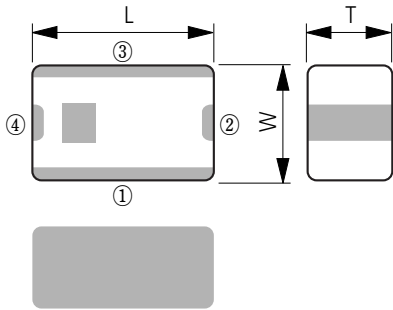

Dimension(mm)		
2520	L	$2.50 \pm 0.20$
	W	$2.00 \pm 0.20$
	T	$1.00 \pm 0.10$
3225	L	$3.20 \pm 0.30$
	W	$2.50 \pm 0.30$
	T	$1.50 \pm 0.10$ ( $1.25 \pm 0.10$ : A3)

Terminal	
Input	④
Output	②
GND	① ③

S11  
S21

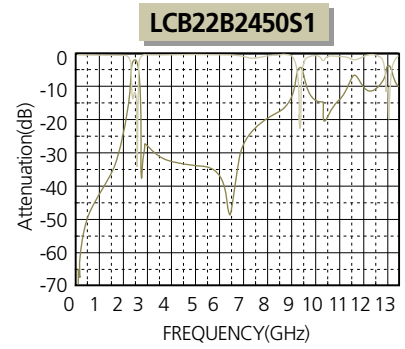
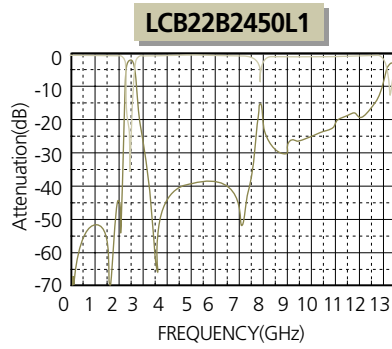
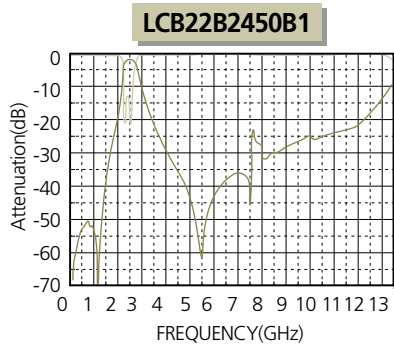

**Dimensions & Frequency Characteristics Band Pass Filter**

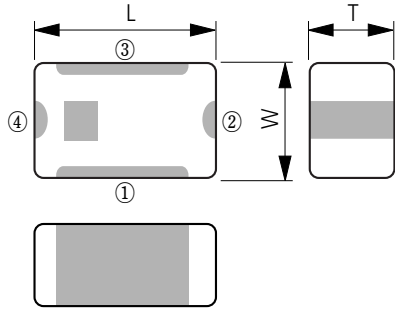

Dimension(mm)		Terminal		
1608	L	1.60+0.2/-0.1	Input	④
	W	0.80+0.2/-0.1	Output	②
	T	0.60±0.10	GND	① ③
2012	L	2.00±0.15		
	W	1.25±0.10		
	T	0.95±0.10 (0.75max : Q3, Q5)		

S11 —  
S21 —

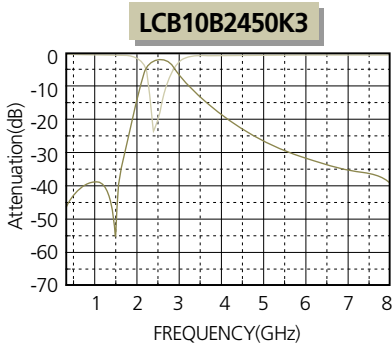
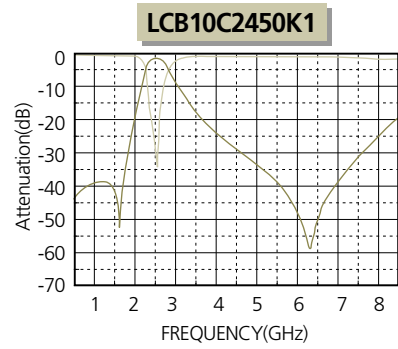
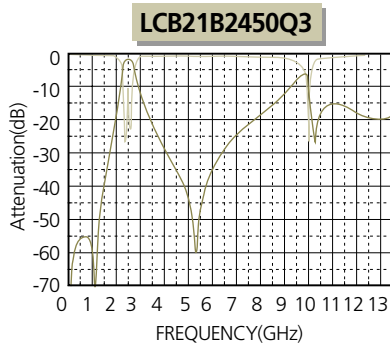
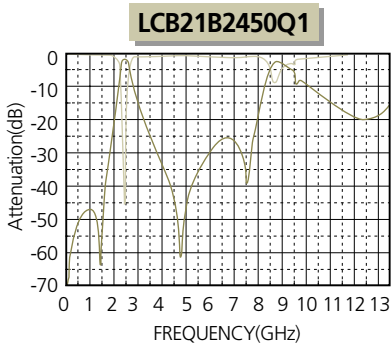



### Dimensions & Frequency Characteristics Band Pass Filter

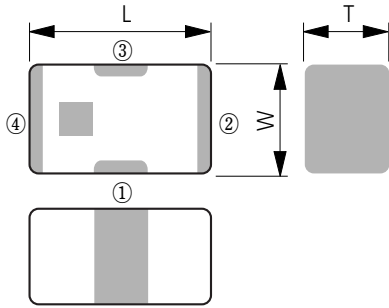

Dimension(mm)		
2012	L	$2.00 \pm 0.15$
	W	$1.25 \pm 0.10$
	T	0.75max

Terminal	
Input	①
Output	③
GND	② ④

S11  
S21

**LCB21B2450F2**

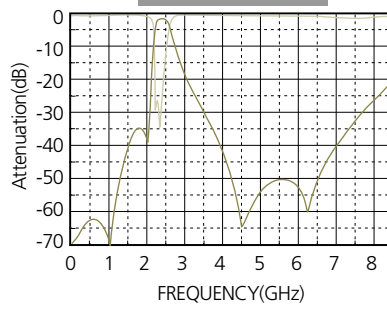

### Dimensions & Frequency Characteristics Band Pass Filter

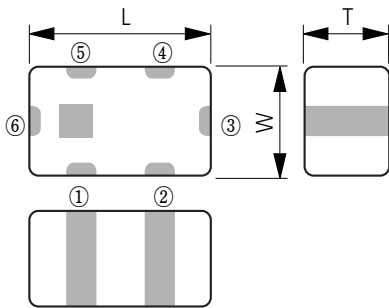

Dimension(mm)		
2520	L	$2.50 \pm 0.20$
	W	$2.00 \pm 0.20$
	T	$1.20 \pm 0.15$

	Terminal	
	A3	B3
Input	⑥	⑥
Output	③	③
GND	① ⑤	① ④
N.C	② ④	② ⑤

S11  
S21

**LCB22G0205A3**

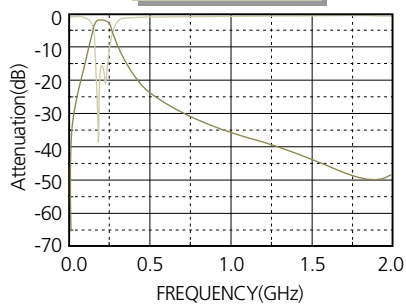

**LCB22G0205B3**

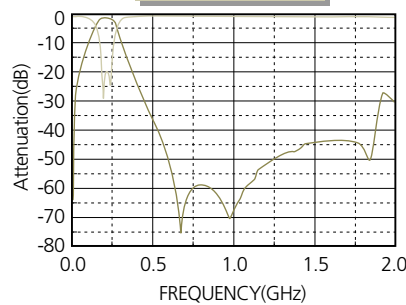

**Dimensions & Frequency Characteristics Low Pass Filter**

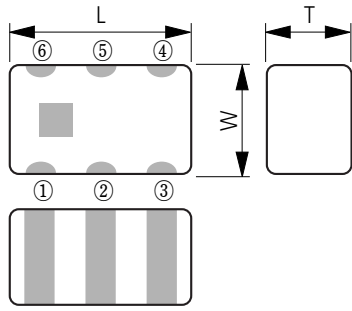

Dimension(mm)	
L	$1.60 \pm 0.10$
W	$0.80 \pm 0.10$
T	$0.60 \pm 0.10$

Terminal	
Input	②
Output	⑤
BND	① ③ ④ ⑥

S11  
S21

**LCL10T2500A1**

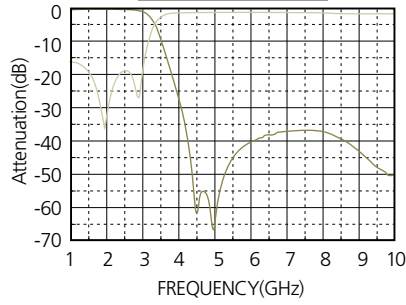

# Appendix

## Soldering Condition

### REFLOW SOLDERING

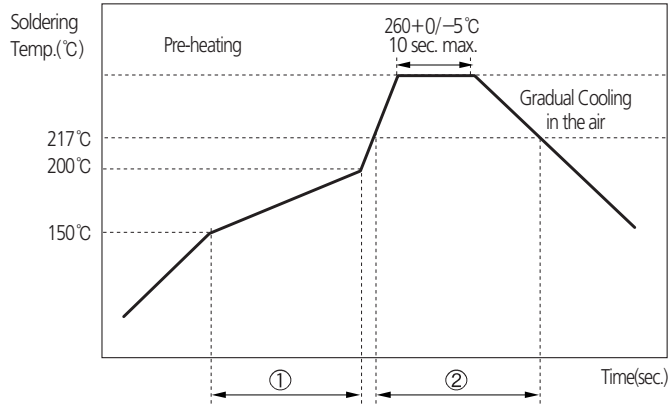

SolderingTemp. (°C)	Pre-heating Time (①, sec.)	Soldering Time (②, sec.)
260+0/-5°C	60~120	60~150

### FLOW SOLDERING

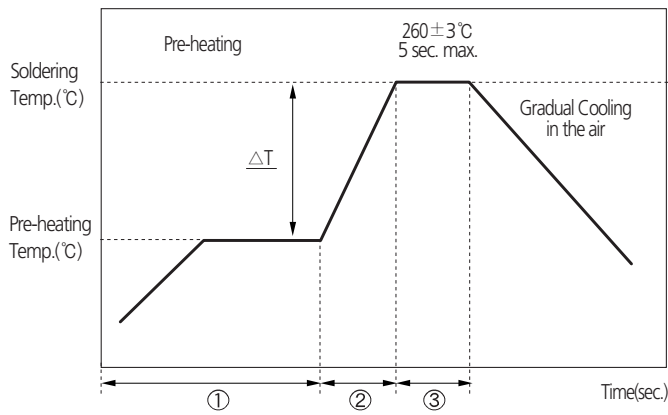

$\Delta T$ (°C)	Soldering Temp. (°C)	Pre-heatingTime (①+②, sec.)	SolderingTime (③, sec.)
$\leq 150$ (1206 and below size)	260±3	$\geq 120$	$\leq 5$

### SOLDER IRON(Hand Soldering)

Variation of Temp.(°C)	Soldering Temp(°C)	Pre-heating Time(sec.)	Soldering Time(sec.)	Cooling Time(sec.)	Condition of Iron Facilities		
					Wattage	Tip Diameter	Soldering Time
$\Delta T \leq 130$	300±10°Cmax.	$\geq 60$ sec.	$\leq 4$ sec.	-	20W max.	3mm max.	4 sec max.

※Caution - Iron tip should not contact with ceramic body directly

Packaging

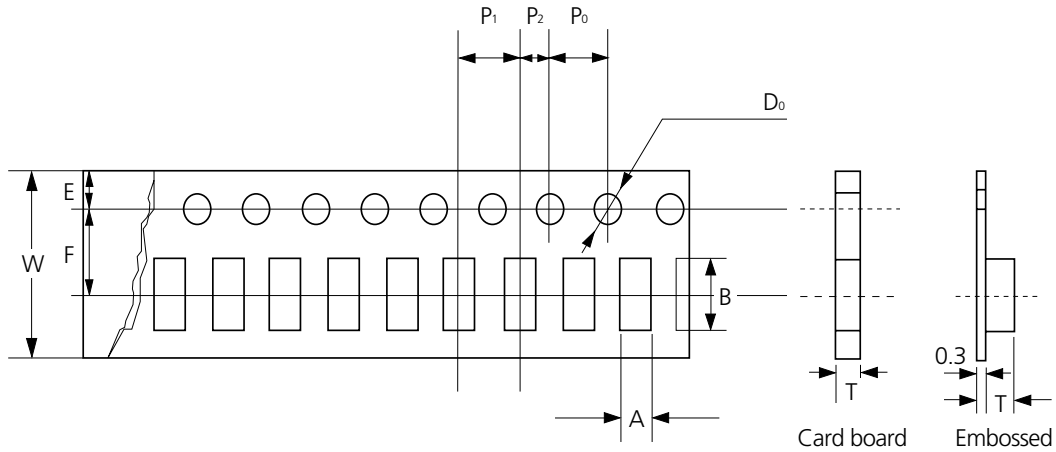

Unit: mm

Type	03	05	10	21			22	31			32	41	43			
Tape	Card	Card	Card	Embossed			Card	Embossed	Embossed			Card	Embossed	Embossed	Embossed	
Chip Thickness	0.3	0.5	0.8	0.85	1.0	1.25	0.85	1.2	0.6	0.8	1.1	0.85	1.3	1.6 (1.2)	1.5	
Chip Cavity	A	0.40 ±0.06	0.65 ±0.1	1.0 ±0.2	1.5 ±0.2	1.5 ±0.2	1.5 ±0.2	1.45 ±0.1	2.39 ±0.10	1.9 ±0.2	1.9 ±0.2	1.9 ±0.2	2.0 ±0.2	2.9 ±0.2	1.9 ±0.2	3.5 ±0.2
	B	0.70 ±0.06	1.15 ±0.1	1.8 ±0.2	2.3 ±0.2	2.3 ±0.2	2.3 ±0.2	2.4 ±0.2	2.79 ±0.10	3.6 ±0.2	3.6 ±0.2	3.6 ±0.2	3.6 ±0.2	3.6 ±0.2	4.9 ±0.2	4.9 ±0.2
T max	0.45	0.8	1.1	1.5	2.0	2.0	0.95 ±0.1	1.80 ±0.10	1.15	1.4	1.4	1.1	1.55	1.8	1.78	
W	8 ±0.2	8 ±0.2	8 ±0.2	8 ±0.2	8 ±0.2	8 ±0.2	8.0 ±0.3	8.0 ±0.3	8 ±0.2	8 ±0.2	8 ±0.2	8 ±0.2	8 ±0.2	12 ±0.2	12 ±0.2	
F	3.5 ±0.05	3.5 ±0.05	3.5 ±0.05	3.5 ±0.05	3.5 ±0.05	3.5 ±0.05	3.5 ±0.05	3.5 ±0.05	3.5 ±0.05	3.5 ±0.05	3.5 ±0.05	3.5 ±0.05	3.5 ±0.05	5.5 ±0.05	5.5 ±0.05	
E	1.75 ±0.1	1.75 ±0.1	1.75 ±0.1	1.75 ±0.1	1.75 ±0.1	1.75 ±0.1	1.75 ±0.1	1.75 ±0.1	1.75 ±0.1	1.75 ±0.1	1.75 ±0.1	1.75 ±0.1	1.75 ±0.1	1.75 ±0.1	1.75 ±0.1	
P <sub>1</sub>	2 ±0.05	2 ±0.05	4.0 ±0.1	4.0 ±0.1	4.0 ±0.1	4.0 ±0.1	4.0 ±0.1	4.0 ±0.1	4.0 ±0.1	4.0 ±0.1	4.0 ±0.1	4.0 ±0.1	4.0 ±0.1	8.0 ±0.1	8.0 ±0.1	
P <sub>2</sub>	2 ±0.1	2 ±0.1	2 ±0.1	2 ±0.1	2 ±0.1	2 ±0.1	2.0 ±0.1	2.0 ±0.05	2 ±0.1	2 ±0.1	2 ±0.1	2 ±0.1	2 ±0.1	2 ±0.1	2 ±0.1	
P <sub>0</sub>	4.0 ±0.1	4.0 ±0.1	4.0 ±0.1	4.0 ±0.1	4.0 ±0.1	4.0 ±0.1	4.0 ±0.1	4.0 ±0.1	4.0 ±0.1	4.0 ±0.1	4.0 ±0.1	4.0 ±0.1	4.0 ±0.1	4.0 ±0.1	4.0 ±0.1	
D <sub>0</sub>	∅1.5 ±0.1	∅1.5 ±0.1	∅1.5 ±0.1	∅1.5 ±0.1	∅1.5 ±0.1	∅1.5 ±0.1	∅1.5 ±0.1 ∕0	∅1.5 ±0.1	∅1.5 ±0.1	∅1.5 ±0.1	∅1.5 ±0.1	∅1.5 ±0.1 ∕0	∅1.5 ±0.1	∅1.5 ±0.1	∅1.5 ±0.1	
Quantity / Reel (PCS)	10,000 (15,000)	10,000	4,000	4,000	3,000	2,000	4,000	2,000	4,000	3,000	3,000	4,000	2,500	2,000 (3,000)	1,000	

• Reel dimensions

Unit: mm

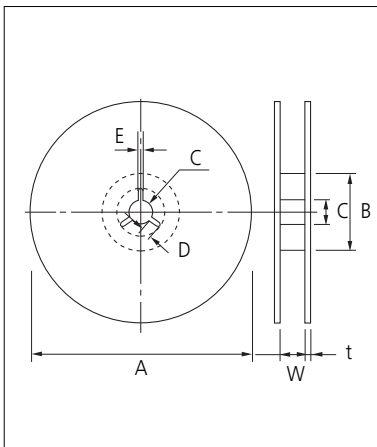

Symbol	Tape Width	A	B	C	D
7" Reel	8mm	∅180+0/-3	∅60+1/-0	∅13±0.3	4±0.2
	12mm	∅180+0/-3	∅60+1/-0	∅13±0.3	4±0.2
10" Reel	8mm	∅258+0/-3	∅80+1/-0	∅13±0.3	4±0.2
	12mm	∅258+0/-3	∅80+1/-0	∅13±0.3	4±0.2
13" Reel	8mm	∅330±2.0	∅80±1.0	∅13±0.3	4±0.2
	12mm	∅330±2.0	∅80±1.0	∅13±0.3	4±0.2

Symbol	Tape Width	E	W	t
7" Reel	8mm	2.0±0.5	9±0.5	1.2±0.2
	12mm	2.0±0.5	13±0.5	1.2±0.2
10" Reel	8mm	2.0±0.5	9±0.5	1.8±0.2
	12mm	2.0±0.5	13±0.5	1.8±0.2
13" Reel	8mm	2.0±0.5	9±0.5	2.2±0.2
	12mm	2.0±0.5	13±0.5	2.2±0.2